

BAHCO®



PRIEMYSEL

Profesionálom dávame to, čo potrebujú



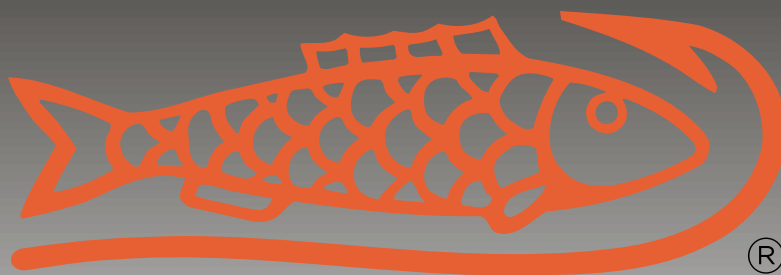

BAHCO

SNA Europe, dcérska spoločnosť spoločnosti Snap-on Inc., je popredným výrobcom ručného náradia a náradia na spracovanie kovov. Výrobky sa predávajú na celom svete prostredníctvom obchodných partnerov pod značkami Bahco, Lindström a Irmo.

Od výroby prvého ručného náradia vo Švédsku v roku 1850 sme vyvíjali a vyrábali náradie pre profesionálov v našich vlastných európskych výrobných závodoch. Naše náradie sa vyznačuje vysokou kvalitou a ergonomickým dizajnom, čo zvyšuje produktivitu, pohodlie a bezpečnosť na pracovisku.

Dnes ponúkame viac ako 15 000 výrobkov, široký sortiment pre používateľov v oblastiach priemyslu, letectva, automobilov, remesiel, záhradníctva a terénnych úprav, ako aj pestovania ovocia a vína.

PROFESIONÁLLOM DÁVAME TO, ČO POTREBUJÚ

V najnovšom vydaní kampane pre priemysel, predstavuje spoločnosť Bahco, výber svojej komplexnej produktovej rady bezpečného, vysoko kvalitného a ergonomického náradia. Obsahuje novinky, najpredávanejšie náradie, dielenské vozíky a iné. Profesionálne riešenie výberu náradia pre priemysel.

Obsah	Strana	Obsah	Strana
Fit & Go Moduly náradia	4–7	Klíúče	52–57
Dielenské vozíky	8–15	Kliešte	58–61
Náradie z nehrdzavajúcej ocele	16–19	Pneumatické náradie	62–63
Náradie pre prácu vo výškach	20–23	Píllové pásy	64
Neiskrivé náradie	24–25	Pilníky a rašple	65
Izolované náradie	26–29	Dierovacie píly	66
Momentové náradie	30–33	Pilky na kov	67
Akumulátorové náradie	34–37	Kufre na náradie	68–69
Skrutkovače a bity	38–43	Tašky na náradie	70–71
Račne a nástrčné kľúče	44–45	Automotive	72
Sady nástrčných kľúčov	46–51	Inšpekčné náradie, Osvetlenie	73

Všetky údaje uvedené v tomto materiály sú orientačné a nezáväzné. Zmeny sú vyhradné. Všetky ceny sú uvedené bez DPH a sú platné do 31.12.2020 alebo do vypredania zásob.

FF1E1002

7

Skrutkovače ERGO™ pre skrutky s drážkou Phillips

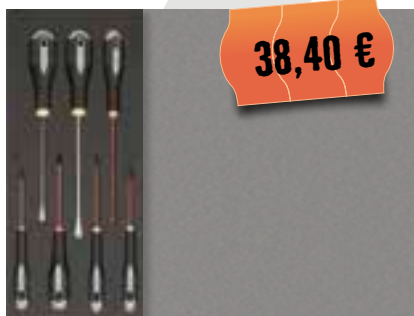

38,40 €

1/3 2/3 3/3

BE-8030	0.6x3.5x75	
BE-8040	0.8x4.0x100	
BE-8242	1.0x5.5x150	
BE-8255	1.2x6.5x150	
BE-8257	1.6x8.0x175	
BE-8611	PH1 x75	
BE-8621	PH2 x100	

FF1E1009

6

Skrutkovače ERGO™ pre skrutky s drážkou TORX®



32,15 €

1/3 2/3 3/3

BE-8908	T8 x75	
BE-8910	T10 x75	
BE-8915	T15 x100	
BE-8920	T20 x100	
BE-8925	T25 x125	
BE-8930	T30 x150	

FF1E1010

6

Izolované skrutkovače ERGO™ pre skrutky s rovnou drážkou a drážkou Phillips

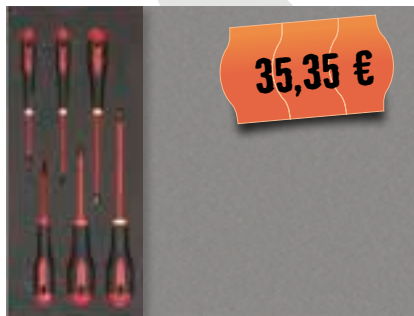

35,35 €

1/3 2/3 3/3

BE-8010S	1,000 V	0.4x2.5x75	
BE-8230S	1,000 V	0.6x3.5x100	
BE-8050S	1,000 V	1.0x5.5x125	
BE-8255S	1,000 V	1.2x6.5x150	
BE-8610S	1,000 V	PH1 x75	
BE-8620S	1,000 V	PH2 x100	

FF1E2001

37

Sada nástrčných klúčov 1/4"

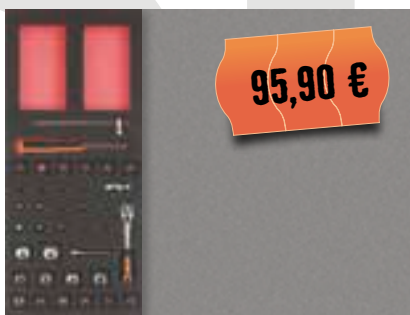

95,90 €

1/3 2/3 3/3

6700SM	1/4"	4-5-5.5-6-7-8-9-10-11-12-13-14 mm	
6700TORX-E	1/4"	E4-E5-E6-E7-E8-E10	
6709M	1/4"	3-4-5-6-8 mm	
6709TORX	1/4"	T8-T9-T10-T15-T20-T25-T27-T30-T40	
6950SL	1/4"	1/4" - 120 mm	
6954	1/4"	1/4" - 115 mm	
6956	1/4"	1/4" - 150 mm	
6960	1/4"	1/4" - 50 mm	
6966	1/4"	1/4" - 35 mm	

FF1E2201

21

Sada nástrčných klúčov 1/2"



162,70 €

1/3 2/3 3/3

7800SM	1/2"	10-11-12-13-14-15-17-18-19-20-21-22-24-27 mm	
7805SM	1/2"	16-21 mm	
8150SL	1/2"	1/2" - 265 mm	
8160-1/2	1/2"	1/2" - 125 mm	
8162-1/2	1/2"	1/2" - 250 mm	
8166-1/2	1/2"	1/2" - 72 mm	
8165-1/2	1/2"	3/8" - 37 mm	

FF1E2204

15

Sada nástrčných klúčov 1/2"



125,55 €

1/3 2/3 3/3

7800DZ	1/2"	3/8; 7/16; 1/2; 9/16; 19/32; 5/8; 11/16; 3/4; 13/16; 7/8; 15/16	
8150RN-1/2	1/2"	1/2" - 267 mm	
8160-1/2	1/2"	1/2" - 125 mm	
8162-1/2	1/2"	1/2" - 250 mm	
8166-1/2	1/2"	1/2" - 72 mm	

FF1E2203

22

Sada nástrčných klúčov 1/2"



151,35 €

1/3 2/3 3/3

7800SM	1/2"	8-9-10-11-12-13-15-16-17-18-19-20-21-22-24-27-30-32 mm	
8150RN-1/2	1/2"	1/2" - 267 mm	
8160-1/2	1/2"	1/2" - 125 mm	
8162-1/2	1/2"	1/2" - 250 mm	
8166-1/2	1/2"	1/2" - 72 mm	

FF1E2209

20

Sada nástrčných klúčov 1/2" s výstupom na skrutky



149,90 €

1/3 2/3 3/3

7809M	1/2"	5-6-7-8-10-12-14-17 mm	
7809TORX	1/2"	T25-T27-T30-T40-T45-T50-T55-T60	
7809XZN	1/2"	6-8-10-12 mm	

FF1E3004

10

Kombinované račňové klúče



104,30 €

1/3 2/3 3/3

1RM	8-9-10-11-12-13-14-15-16-17 mm	
-----	--------------------------------	--

1/3 MODULY

FF1E4001

Kliešte

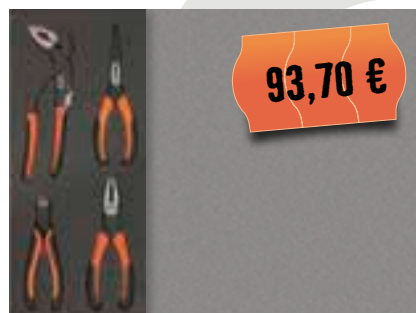

93,70 €

	1/3	2/3	3/3
2628 G-180IP	2.5; 2.0	180 mm	
8231 IP	51 mm	225 mm	
2430 G-200 IP	200 mm		
2101G-160IP	160 mm		

FF1E4002

Kliešte na poistné krúžky



79,65 €

	1/3	2/3	3/3
2900-180	180 mm		
2890-180	180 mm		
2990-180	180 mm		
2800-180	180 mm		

FF1E5003

Úderové náradie



57,60 €

	1/3	2/3	3/3
481-300	300 g; 105x300x23 mm		
3735-5-120	120 mm - Ø 5 mm		
3739-300	300 mm		
3740-100	100 mm - 15 mm		
3740-125	125 mm - 15 mm		
3740-150	150 mm - 18 mm		
3740-200	200 mm - 23 mm		
3733	120 mm - Ø 2-4-6 mm		

Penové moduly s náradím:

Šité na mieru. Zamerané na používateľa.

Naše systémy na ukladanie náradia sú výsledkom našich mnohoročných skúseností v spolupráci s ich používateľmi a partnermi z letectva a priemyslu – prispôsobené a navrhnuté tak, aby uľahčili každodennú prácu.

- Pasujú do všetkých mobilných dielenských vozíkov Bahco a pracovných stolov Bahco
- Veľký výber modulov



Konfigurátor BETMS

bahco.com/sk_sk/betms



Odolné voči: voda, skydrol, benzín



Odolné voči ÚV žiareniu



Tlmič nárazov



100 % kontrola 2-farebná pena



Systém zatlačenia (Push)

1/3

181 x 445 mm

2/3

362 x 445 mm

3/3

543 x 445 mm

3/3 MODULY

FF1F4005

Izolované kliešte a kliešte s posuvným klídom

5

139,10 €



1/3 2/3 3/3

2101S-160	1,000 V -	160 mm	
2430 S-200	1,000 V -	200 mm	
2427 S-200	1,000 V -	200 mm	
8224 IP		250 mm	
2628 S-180	1,000 V -	180 mm	

FF1F5001

Pilníky, kliešte, meracie pásmo

10

141,45 €



1/3 2/3 3/3

1-100-08-1-2		150 mm-8"	
1-160-08-1-2		150 mm-8"	
1-170-08-1-2		200 mm-8"	
1-210-08-1-2		200 mm-8"	
1-230-08-1-2		200 mm-8"	
2430 G-200 IP		200 mm	
2628G-200IP		3.0; 2.5 - 200 mm	
7224		250 mm	
2101G-160IP		160 mm	
MTB-3-16	3 m -	16 mm	

FF1A1005

Skrutkovače, bity, imbusové kľúče

66

171,25 €



1/3 2/3 3/3

59S/31-1		1/4": PH1-PH2-PH3-PH2G; T25-T15-T20-T10-T27-T30; H3-H4-H5-H6; PZ1-PZ2-PZ3; 0.8x5.5-0.6x4.5-0.5x3.0; KM653-QR	
BE-8020		0.5 x 3.0 x 60	
BE-8240		0.8 x 4.0 x 175	
BE-8250		1.0 x 5.5 x 150	
BE-8255		1.2 x 6.5 x 150	
BE-8865		1.6 x 8.0 x 175	
BE-8602		PH2 x 25	
BE-8611		PH1 x 75	
BE-8621		PH2 x 100	
BE-8630		PH3 x 150	
BE-9585		T9-T10-T15-T20-T25-T27-T30-T40	
BE-8800		PZ0 x 60	
BE-8811		PZ1 x 75	
BE-8821		PZ2 x 100	
BE-8802		PZ2 x 25	
BE-8830		PZ3 x 150	
BE-8910		T10 x 75	
BE-8915		T15 x 100	
BE-8920		T20 x 100	
BE-8925		T25 x 125	
BE-9678		1.5-2-2.5-3-4-5-6-8-10 mm	

FF1A3004

Kombinované kľúče a kombinované račňové kľúče

30

224,10 €



1/3 2/3 3/3

111M		6-7-8-9-10-11-12-13-14-15-16-17-18-19-20-21-22-24 mm	
1RM		8-9-10-11-12-13-14-15-16-17-18-19 mm	

Kompletný sortiment modulov s náradím nájdete - v online Bahco katalógu:



Vybavte si vaše dielenské vozíky náradím. Na výber máme z viac ako **200 modulov** s rôznym náradím v rôznych veľkostiach modulov 1/3, 2/3 a 3/3.

1/3

181 x 445 mm

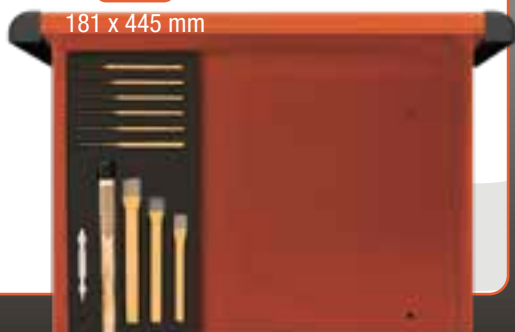

2/3

362 x 445 mm



3/3

543 x 445 mm

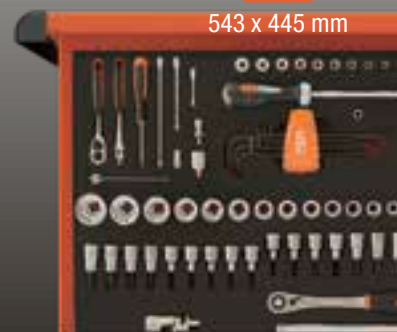

DIELENSKÉ VOZÍKY



Protišmyková gumená pracovná plocha



Plne vysúvateľné zásuvky



Vysoká nosnosť



Ochrana rohov



Ø125 x 36 mm



Centrálné zamykanie s rúrkovým kľúčom



Séria 1472K Dielský vozík, bez náradia

Séria 1482K Nadstavba k dielským vozíkom, bez náradia

- Vysoká stabilita vďaka dvojstennému vystuženému rámu
- Ochrana zásuvky pred vypadnutím náradia



1482K	510 mm	385 mm	690 mm
1472K	510 mm	950 mm	690 mm

Štandardné RAL-farby





379,00 €

71 kg



1472K5

Vnútročné rozmery zásuviek:
(1x) 543 x 445 x 53 mm
(2x) 543 x 445 x 118 mm
(2x) 543 x 445 x 184 mm

399,00 €

75 kg



1472K6

Vnútročné rozmery zásuviek:
(3x) 543 x 445 x 53 mm
(2x) 543 x 445 x 118 mm
(1x) 543 x 445 x 249 mm

429,00 €

78 kg



1472K7

Vnútročné rozmery zásuviek:
(5x) 543 x 445 x 53 mm
(1x) 543 x 445 x 118 mm
(1x) 543 x 445 x 249 mm

459,00 €

79 kg



1472K8

Vnútročné rozmery zásuviek:
(6x) 543 x 445 x 53 mm
(1x) 543 x 445 x 118 mm
(1x) 543 x 445 x 184 mm

Kód výrobku	Zásuvky	Farba		
1472K5	5	Oranžová		RAL 2009
1472K5BLACK	5	Čierna		RAL 9005
1472K5BLUE	5	Modrá		RAL 5002
1472K5RED	5	Červená		RAL 3001
1472K5GREY	5	Šedá		RAL 9022
1472K5WHITE	5	Biela		RAL 9003
1472K6	6	Oranžová		RAL 2009
1472K6BLACK	6	Čierna		RAL 9005
1472K6BLUE	6	Modrá		RAL 5002
1472K6RED	6	Červená		RAL 3001
1472K6GREY	6	Šedá		RAL 9022
1472K6WHITE	6	Biela		RAL 9003

Kód výrobku	Zásuvky	Farba		
1472K7	7	Oranžová		RAL 2009
1472K7BLACK	7	Čierna		RAL 9005
1472K7BLUE	7	Modrá		RAL 5002
1472K7RED	7	Červená		RAL 3001
1472K7GREY	7	Šedá		RAL 9022
1472K7WHITE	7	Biela		RAL 9003
1472K8	8	Oranžová		RAL 2009
1472K8BLACK	8	Čierna		RAL 9005
1472K8BLUE	8	Modrá		RAL 5002
1472K8RED	8	Červená		RAL 3001
1472K8GREY	8	Šedá		RAL 9022
1472K8WHITE	8	Biela		RAL 9003

Nadstavba, bez náradia

1482K4



Vnútročné rozmery zásuviek:
(3x) 543 x 445 x 53 mm
(1x) 543 x 445 x 118 mm



399,00 €

Kód výrobku	Zásuvky	Farba		
1482K4	4	Oranžová		RAL 2009
1482K4BLACK	4	Čierna		RAL 9005
1482K4BLUE	4	Modrá		RAL 5002
1482K4RED	4	Červená		RAL 3001
1482K4GREY	4	Šedá		RAL 9022
1482K4WHITE	4	Biela		RAL 9003

Príslušenstvo pre sériu 1472K / 1482K



Kód výrobku	Popis	€
1477K-AC18	Držiak rolne papiera	41,55
1477K-AC19	Bočná priehradka	36,90
1477K-AC20	Držiak pre spreje, plechovky	32,30

Kód výrobku	Popis	€
1477K-AC21	Držiak pre pneumatické náradie	69,20
1477K-AC22	Perforovaná bočná stena	50,75
1470KAC01	Protišmyková podložka pre zásuvky	13,05

DIELENSKÉ VOZÍKY

Séria 1475K, 1485K

Dielenský vozík a nadstavba, bez náradia

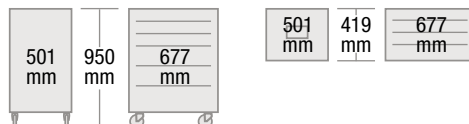

STOP
Ø 125 x 30 mm



1475K6

Vnútorne rozmery zásuviek:
(6x) 543 x 445 x 53 mm
(1x) 543 x 445 x 118 mm
(1x) 543 x 445 x 184 mm



1475K7

Vnútorne rozmery zásuviek:
(6x) 543 x 445 x 53 mm
(1x) 543 x 445 x 118 mm
(1x) 543 x 445 x 184 mm



1475K8

Vnútorne rozmery zásuviek:
(6x) 543 x 445 x 53 mm
(1x) 543 x 445 x 118 mm
(1x) 543 x 445 x 184 mm



1485K4

Nadstavba so 4 zásuvkami
Vnútorne rozmery zásuviek:
(3x) 543 x 445 x 53 mm
(1x) 543 x 445 x 118 mm

Kód výrobku	Popis	Farba
1475K6	6	Oranžová RAL 2009
1475K6BLACK	6	Čierna RAL 9005
1475K6BLUE	6	Modrá RAL 5002
1475K6RED	6	Červená RAL 3001
1475K7	7	Oranžová RAL 2009
1475K7BLACK	7	Čierna RAL 9005
1475K7BLUE	7	Modrá RAL 5002
1475K7RED	7	Červená RAL 3001

Kód výrobku	Popis	Farba
1475K8	8	Oranžová RAL 2009
1475K8BLACK	8	Čierna RAL 9005
1475K8BLUE	8	Modrá RAL 5002
1475K8RED	8	Červená RAL 3001
1485K4	4 – Nadstavba	Oranžová RAL 2009
1485K4BLACK	4 – Nadstavba	Čierna RAL 9005
1485K4BLUE	4 – Nadstavba	Modrá RAL 5002
1485K4RED	4 – Nadstavba	Červená RAL 3001

Štandardné RAL-farby

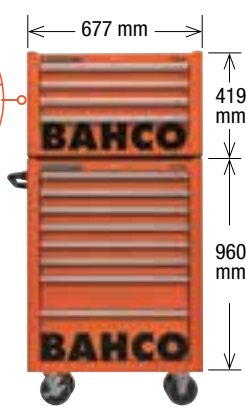

Dielenský vozík 1475K8 s nadstavbou 1485K4

DIELENSKÉ VOZÍKY

Séria 1475KXL Dielenský vozík XL

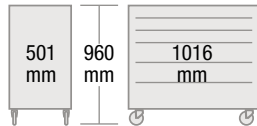

1016 mm



1475KXL6

Dielenský vozík XL so 6 zásuvkami

Vnútročné rozmery zásuviek:
(2x) 881 x 445 x 53 mm
(3x) 881 x 445 x 118 mm
(1x) 881 x 445 x 184 mm

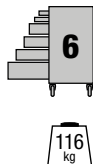

Kód výrobku	Zásuvky	Farba
1475KXL6	6	Oranžová RAL 2009
1475KXL6BLACK	6	Čierna RAL 9005
1475KXL6BLUE	6	Modrá RAL 5002
1475KXL6RED	6	Červená RAL 3002



Ø 125 x 50 mm

1475KXL6C

Dielenský vozík XL so 6 zásuvkami a bočnou skrinkou

Vnútročné rozmery zásuviek:
(3x) 543 x 445 x 53 mm
(2x) 543 x 445 x 118 mm
(1x) 543 x 445 x 249 mm



Kód výrobku	Zásuvky	Farba
1475KXL6C	6	Oranžová RAL 2009
1475KXL6CBLACK	6	Čierna RAL 9005



Ø 125 x 50 mm

1475KXL12

Dielenský vozík XL s 12 zásuvkami

Vnútročné rozmery zásuviek:
(1x) 881 x 445 x 53 mm
Zásuvky na ľavej strane
(4x) 284 x 445 x 53 mm
(1x) 284 x 445 x 118 mm
(1x) 284 x 445 x 184 mm

Zásuvky na pravej strane
(2x) 540 x 445 x 53 mm
(2x) 540 x 445 x 118 mm
(1x) 540 x 445 x 184 mm



Kód výrobku	Zásuvky	Farba
1475KXL12	12	Oranžová RAL 2009
1475KXL12BLACK	12	Čierna RAL 9005

DIELENSKÉ VOZÍKY

Pracovné plochy pre Série 1475K a 1470K

■ Vhodné pre 26" dielenské vozíky 1475K a 1470KSS
alebo 40" dielenské vozíky 1475KXL



1470K-ACTSS 26" Pracovná doska z nerezovej ocele



1470KXL-ACTSS 40" Pracovná doska z nerezovej ocele

1470K-ACTW 26" Pracovná doska z dreva

1470KXL-ACTW 40" Pracovná doska z dreva



1470K-ACTD 26" Pracovná doska z MDF

1470KXL-ACTD 40" Pracovná doska z MDF



1470K-AC7 26" Pracovná doska z plastu s priehradkami na malé časti

Kód výrobku	Popis	€
1470K-ACTSS	26" Pracovná doska z nerezovej ocele	210,00
1470KXL-ACTSS	40" Pracovná doska z nerezovej ocele	284,00
1470K-ACTW	26" Pracovná doska z dreva	185,00
1470KXL-ACTW	40" Pracovná doska z dreva	255,00

Kód výrobku	Popis	€
1470K-ACTD	26" Pracovná doska z MDF	125,00
1470KXL-ACTD	40" Pracovná doska z MDF	162,00
1470K-AC7	26" Pracovná doska z plastu	83,00

Príslušenstvo pre Sériu 1475K a 1470K



1470K-AC1
Bočná polička



1470K-AC2
Držiak rôzneho náradia



1470K-ACSIDE
Perforovaná bočná stena



1470K-AC3
Držiak pre spreje, plechovky



1470K-AC4
Bočná priehradka



1470KAC01
Protišmyková podložka pre zásuvky



1470K-AC8
Perforovaný panel na náradie

Kód výrobku	Popis	€
1470K-AC1	Bočná polička	77,00
1470K-AC2	Držiak rôzneho náradia	92,00
1470K-AC3	Držiak pre spreje, plechovky	30,00
1470K-AC4	Bočná priehradka	41,00

Kód výrobku	Popis	€
1470K-ACSIDE	Perforovaná bočná stena	72,00
1470K-AC8	Perforovaný panel na náradie oranžový	86,00
1470KAC01	Protišmyková podložka pre zásuvky	13,40



Všetky ceny sú uvedené bez DPH. Platné do 31.12.2020 alebo do vypredania zásob.

DIELENSKÉ VOZÍKY S NÁRADÍM

1472K6BKFF7SD

Dielenský vozík so 6 zásuvkami spolu s 214 kusmi náradia

■ 3/3 moduly náradia 543 x 445 mm

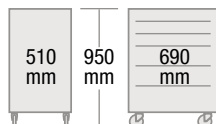
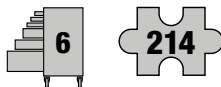

589,00 €

FF1A81

Skrutkovače & Klúče



B191.040.100	⌀ 4.0x0.8x100	
B190.055.125	⌀ 5.5x1.2x125	
B190.065.150	⌀ 6.5x1x150	
B192.000.075	PH0x75	
B192.001.100	PH1x100	
B192.002.125	PH2x125	
111M	6-7-8-9-10-11-12-13-14-15-16-17-19-21-22-24mm	
BE-9770-B	● 1.5-2-2.5-3-4-5-6-8-10 mm	

FF1A82

Úderové náradie & Kliešte



3734S/6-T	⌀ 2-3-4-5-6-8 mm; 150 mm	
479-16	450 g	
3625W-35	⌀ 35 mm	
MTG-3-16	3 m; 16 mm	
KB18-01	18x161 mm	
KSBG18-10 DISPEN	18 mm, x10	

2101G180	180 mm	
2678G-180	2.0; 1.4; 180 mm	
2470G-200	200 mm	
2530	350 mm	
8224	250 mm	

FF1A179

Nástrčné klúče a príslušenstvo



1/4" + 1/2"



2058-BR	● 1/4", 8 mm	
59/S100B-T	● 1/4": 4.5-5.5; PH1(x2)-PH2(x9)-PH3-PH2G(x5); PZ1(x2)-PZ2(x9)-PZ3, T10(x3)-T15(x5)-T20(x15)-T25(x8)-T27-T30(x15)-T40(x3)-TR10-TR15-TR20-TR25-TR30; HEX3-HEX4(x3)-HEX5-HEX6(x3)-HEX8; R1-R2	
6950SL	● 1/4" ● 1/4" 120 mm	
8150SL	● 1/2" ● 1/2" 265 mm	
6700SM	● 1/4" ○ 4-4.5-5-5.5-6-7-8-9-10-11-12-13-14 mm	
A6800DM	● 1/4" ○ 7-8-9-10-11-13 mm	
6956	● 1/4" ● 1/4" 150 mm	
6961	● 1/4" ● 1/4" 100 mm	
6966	● 1/4" ● 1/4" 35 mm	

7800SM	● 1/2" ○ 10-11-12-13-14-15-16-17-18-19-20-21-22-24-27-30-34 mm	
7805DM	● 1/2" ○ 10-13-17-18-19-16-21-22 mm	
7805SM	● 1/2" ○ 16-21 mm	
8160-1/2	● 1/2" ● 1/2" 125 mm	
8162-1/2	● 1/2" ● 1/2" 250 mm	
8166-1/2	● 1/2" ● 1/2" 72 mm	
8156-1/2	● 1/2" ● 1/2" 257 mm	
7106S0080	● 1/2" ○ 5/16"	
6973	● 1/4" ○ 1/4"	
70S	● 5/16" - ● T45-T50-T55	

DIELENSKÉ VOZÍKY S NÁRADÍM

1472K6/S1

Dielenský vozík so 6 zásuvkami spolu so 177 kusmi náradia

■ 3/3 moduly náradia 543 x 445 mm

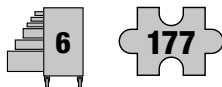

1.499,00 €

FF1A04

Kľúče



S4RM	8-11-12-15-16-19 mm	
111M	6-7-8-9-10-11-12-13-14-15-16-17-18-19-21-22-24-27-32 mm	
6M	6-7-8-9-10-11-12-13-14-15-17-19 mm	
9071C	27 mm; 208 mm / 8"	

FF1A05

Nástrčné kľúče s príslušenstvom



BE-9678	1.5-2-2.5-3-4-5-6-8-10 mm	
SBS60	1/4" 4-4.5-5-5.5-6-7-8-9-10-11-12-13-14 mm	
SBS61	1/4" - 145 mm	
SBS63-2	1/4" - 150 mm	
SBS63-4	1/4" - 100 mm	
SBS63-6	1/4" - 150 mm	
SBS64	1/4" 1/4" - 125 mm	
SBS65	1/4" 1/4" - 32.5 mm	
SBS67	1/4" - 153 mm	
SBS69	1/4" 3/8" - 25 mm	
SBS80	1/2" 10-11-12-13-14-15-16-17-18-19-21-22-24-27-30-32 mm	
SBS88	1/2" 3/8" - 37 mm	

59S/31-1	1/4": PH1-PH2-PH3-PH2G; T25-T15-T20-T10-T27-T30; H3-H4-H5-H6; P21-P22-P23; 0.8x6.5-0.6x4.5-0.5x3.0; KM653-QR	
6956	1/4" 1/4" - 150 mm	
6972H	1/4" 1/4" - 26 mm	
7809M	1/2" - 5-6-7-8-10-12-14-17-19 mm	
7809TORX	1/2" - T20-T25-T27-T30-T40-T45-T50-T55-T60	
808050	1/4" 1/2" - 125 mm	
8150SL	1/2" 1/2" - 265 mm	
8154-1/2	1/2" 283 mm	
8160-W	1/2" 1/2" - 125 mm	
8162-1/2	1/2" 1/2" - 250 mm	
8166-1/2	1/2" 1/2" - 72 mm	

FF1A06

Skrutkovače a kliešte



BE-8020L	0.5 x 3.0 x 75	
BE-8040	0.8 x 4.0 x 100	
BE-8150	1.0 x 5.5 x 100	
BE-8255	1.2 x 6.5 x 150	
BE-8256	1.6 x 8.0 x 150	
BE-8350	1.0 x 5.5 x 25	
BE-8601	PH1 x 25	
BE-8610	PH1 x 75	
BE-8620	PH2 x 100	
BE-8910	T10 x 75	
BE-8915	T15 x 100	
BE-8920	T20 x 100	
BE-8925	T25 x 125	
BE-8927	T27 x 125	
BE-8930	T30 x 150	

MTB-3-16	3 m; 16 mm	
2101B-160IP	160 mm	
2427 G-200 IP	200 mm	
2535L	20 mm	
2628 G-160IP	1.8; 2.0; 160 mm	
2951-180	2.0; 180 mm	
5515T-52	30 mm; 180-690 mm	
8224 IP	250 mm	

FF1A07

Pilníky, úderové náradie, pilka na kov



3734N	150 mm - 3-5-6 mm	
3735N-4-120	120 mm - 4 mm	
3740-175	175 mm - 21 mm	
SQZ150003	170 mm	
1-100-08-2-2	200 mm	
1-210-08-2-2	200 mm	
1-230-08-2-2	200 mm	
2744	190 mm	

3625W-35	35 mm; 100x300 mm	
3745-150	150 mm; 6 mm; 17x11 mm	
481-400	400 g; 112x300x25 mm	
782-U	290 mm	
317	432 mm / 17"	



Moduly sú k dispozícii aj jednotlivo.

1472K7/S1

Dielenský vozík so 7 zásuvkami spolu s 300 kusmi náradia

■ 3/3 moduly náradia 543 x 445 mm



2.399,00 €



Moduly sú k dispozícii aj jednotlivé.

FF1A08

Nástrčné kľúče s príslušenstvom



1/4"
3/8"
1/2"

A6800DM	1/4"	5.5-6-7-8-9-10-11-12-13 mm	
A7402DM	1/4"	10-11-12-13-14-15-16-17-18-19 mm	
1544		76 mm - 0.03-1.00 mm	
6700SM	1/4"	5.5-6-7-8-9-10-11-12-13 mm	
6709M	1/4"	3-4-5-6-8 mm	
6709PH	1/4"	PH1-PH2-PH3	
6709TORX	1/4"	T8-T9-T10-T15-T20-T25-T27-T30-T40	
6950SL	1/4"	1/4" - 120 mm	
6954	1/4"	1/4" - 115 mm	
6956	1/4"	1/4" - 150 mm	
6958	1/4"	153 mm	
6960	1/4"	50 mm	
6961	1/4"	101 mm	
6962	1/4"	152 mm	
6962L	1/4"	335 mm	
6966	1/4"	1/4" - 35 mm	
6972H	1/4"	1/4" - 26 mm	
7400SM	1/4"	6-7-8-9-10-11-12-13-14-15-16-17-18-19-22 mm	
7407H	1/4"	3/8" - 26 mm	
7409M	3/8"	3-4-5-6-7-8-10 mm	
7409TORX	3/8"	T25-T27-T30-T40-T45-T50	
7750SL	3/8"	3/8" - 205 mm	
7754	3/8"	3/8" - 160 mm	
7758	3/8"	250 mm	
7760	3/8"	75 mm	
7761	3/8"	127 mm	
7762	3/8"	252 mm	
7764	3/8"	1/4" - 24,7 mm	
7765	1/4"	3/8" - 25 mm	
7766	3/8"	3/8" - 51,5 mm	
7800SM	1/2"	10-11-12-13-14-15-16-17-18-19-21-22-24-27-30-32 mm	
7807H	1/4"	1/2" - 38 mm	
7809M	1/2"	5-6-7-8-10-12-14-17-19 mm	
7809TORX	1/2"	T20-T25-T27-T30-T40-T45-T50-T55-T60	
8150SL	1/2"	1/2" - 265 mm	
8154-1/2	1/2"	1/2" - 283 mm	
8160-1/2	1/2"	1/2" - 125 mm	
8162-1/2	1/2"	1/2" - 250 mm	
8164-1/2	3/8"	1/2" - 33 mm	
8165-1/2	1/2"	3/8" - 37 mm	
8166-1/2	1/2"	1/2" - 72 mm	
8964	1/2"	3/4" - 45 mm	

FF1A09

Kľúče



111M	6-7-8-9-10-11-12-13-14-15-16-17-18-19-21-22-24-27-30-32 mm	
1320RM	8-9-10-11-12-13 mm	
6M	6-7-8-9-10-11-12-13-14-15-16-17-18-19-20-22-24-27-30-32 mm	
9071C	27 mm; 208 mm / 8"	

FF1A10

Skrutkovače a meracie náradie



BE-8020L	0.5 x 3.0 x 75	
BE-8030	0.6 x 3.5 x 75	
BE-8155	1.2 x 6.5 x 125	
BE-8260	1.6 x 8.0 x 175	
BE-8350	1.0 x 5.5 x 25	
BE-8601	PH1 x 25	
BE-8602	PH2 x 25	
BE-8610	PH1 x 75	
BE-8620	PH2 x 100	
BE-8630	PH3 x 150	
BE-8910	T10 x 75	
BE-8915	T15 x 100	
BE-8920	T20 x 100	
BE-8925	T25 x 125	
BE-8927	T27 x 125	
BE-8930	T30 x 150	
BE-8940	T40 x 150	
BE-9770	1.5-2-2.5-3-4-5-6-8-10 mm	
MTB-3-16	3 m; 16 mm	
1150-112H/P	235 x 75 x 9	
1177-SCRIBE	70°; 230 mm	
2820EF2	200 mm	
5515T-52	30 mm; 180-690 mm	
59S/31-1	1/4"; PH1-PH2-PH3-PH2G; T25-T15-T20-T10-T27-T30; H3-H4-H5-H6; PZ1-PZ2-PZ3; 0.8x5.5-0.6x4.5-0.5x3.0; KM653-QR	
808050S	1/4"; 68 mm	
2047-0.8-4	100 mm	
2047PR-1-2	PH1-2 x 100 mm	

FF1A12

Rezacie a uderové náradie



FS-8	165 mm	
1-100-06-1-2	150 mm	
1-100-06-2-2	150 mm	
1-160-06-1-2	150 mm	
1-210-06-1-2	150 mm	
1-230-06-1-2	150 mm	
2509	525 mm	
2535F2	10 mm; 535 mm	
3625W-35	35 mm; 100x300 mm	
3734	150 mm; 3-5-8 mm	
3735-4-120	120 mm; 4 mm	
3740-150	150 mm; 18 mm	
3745-150	150 mm; 6 mm	
481-300	300 g; 105x300x23 mm	
481-500	500 g; 118x300x27 mm	
8158-1/2	1/2"; 390 mm	
319	300 mm / 11"	

FF1A11

Kliešte



2101GC-125IP	125 mm	
2101GC-160IP	160 mm	
21HDGC-200IP	200 mm	
2427 GC-200IP	200 mm	
2430 GC-200 IP	200 mm	
2628 GC-160IP	2.0; 1.8; 160 mm	
2928	160-200-250 mm	
2951-250	3.0; 250 mm	
2952-165	165 mm	
8224CIP	250 mm	

NÁRADIE Z NEHRDZAVEJÚCEJ OCELE



"Náradie z nehrdzavejúcej ocele sa používa pri prácach v náročnom kritickom prostredí, kde nesmie dôjsť ku korózii. Náradie vyrobené z bežnej ocele môže zanechávať častice na skrutkách, maticiach atď., čo následne vedie k tvorbe hrdze. Použitím náradia Bahco z nehrdzavejúcej ocele sa tomuto riziku môžete vyhnúť.

Používateľ má prístup k náradiu bez toho, aby musel opustiť čistú miestnosť, čo výrazne zvyšuje produktivitu.

Nehrdzavejúca oceľ hrá dôležitú úlohu v odvetviach ako:

- Potravinársky priemysel
- Letectvo a vesmírny priemysel
- Zdravotníctvo
- Farmaceutický priemysel
- Chemický priemysel
- Auto priemysel
- Všade tam, kde je kritická, sterilná výroba, a tam kde je čistá miestnosť alebo korozívne prostredie"

Toto náradie je vyrobené z nehrdzavejúcej ocele 420





Rukoväť z nerezovej ocele môže byť pripojená na obidve strany

1.499,00 €

65 kg

STAINLESS STOP
Ø 125x30 mm

45 KG 600 KG
Veľmi vysoká nosnosť



1.795,00 €

121 kg

STAINLESS STOP
Ø 125x50 mm

1470K7SS

Dielený vozík z nerezovej ocele so 7 zásuvkami



Vnútorne rozmery zásuviek:
(5x) 543 x 445 x 53 mm
(1x) 543 x 445 x 118 mm
(1x) 543 x 445 x 249 mm

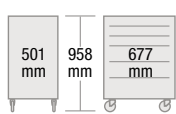

1470KXL7SS

Dielený vozík z nerezovej ocele XL so 7 zásuvkami

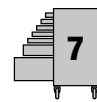

Vnútorne rozmery zásuviek:
(5x) 543 x 445 x 53 mm
(1x) 543 x 445 x 118 mm
(1x) 543 x 445 x 249 mm

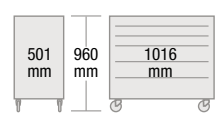

Pre správne uloženie náradia v dielenskom vozíku existuje možnosť uloženia do vložiek vyrobených z PMMA Altuglas®. Kontaktujte nás.



Zásuvky a vodiace kolajničky z nerezovej ocele, držiaky z hliníka

NÁRADIE Z NEHRDZAVEJÚCEJ OCELE



Kombinované kľúče z nehrdzavejúcej ocele

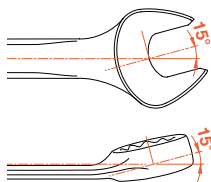

- Podľa normy ISO 691
- Vysoká pevnosť a tvrdosť
- Vynikajúca odolnosť voči korózii

BAHCO	mm	mm	g	€
SS002-6	6	105	25	14,70
SS002-8	8	120	25	18,15
SS002-10	10	120	25	22,10
SS002-11	11	135	45	23,80
SS002-12	12	135	45	25,50
SS002-13	13	150	60	26,55
SS002-14	14	150	60	27,40
SS002-15	15	175	80	28,80
SS002-16	16	175	70	30,30
SS002-17	17	195	115	31,10
SS002-19	19	195	115	33,15
SS002-21	21	195	110	41,40
SS002-22	22	215	160	43,30
SS002-24	24	215	160	49,95
SS002-27	27	215	160	70,95

Nastaviteľné kľúče z nehrdzavejúcej ocele



- I Podľa normy ISO 6787
- Vysoká pevnosť a tvrdosť
- Vynikajúca odolnosť voči korózii

BAHCO	mm	mm	g	€
SS001-100	13	100	100	41,25
SS001-150	18	150	120	52,55
SS001-200	24	200	240	70,45
SS001-250	30	250	400	86,90
SS001-300	36	300	340	112,50
SS001-375	46	375	1360	169,00
SS001-450	55	450	1840	213,00
SS001-600	60	600	3200	378,00



231,00 €

SS002-9-2

Sada kombinovaných kľúčov z nehrdzavejúcej ocele

mm 8 10 11 12 13 14 15 17 19



BE-9770i

Sada zahnutých imbusových kľúčov s guľičkou



- Pre lepší prístup z nehrdzavejúcej ocele



14,95 €

M 1.5 2 2.5 3 4 5 6 8 10

NÁRADIE Z NEHRDZAVEJÚCEJ OCELE



BE-9881i

Sada ERGO™ skrutkovačov z nehrdzavejúcej ocele

6

■ ISO 2380 / DIN 5264



0.5x3.0 mm 1.0x5.5 mm
0.8x4.0 mm 1.2x6.5 mm



PH1
PH2

ergo®



23,95 €

■ Ergonomická trojzložková rukoväť

Skrutkovače ERGO™ z nehrdzavejúcej ocele pre skrutky s drážkou Phillips®

ergo®



BAHCO	mm	mm	mm	€
BE-8610i	⊕ PH 1 x 75	27 x 122	197	5,40
BE-8620i	⊕ PH 2 x 100	36 x 122	222	6,45

Kliešte s posuvným kĺbom z nehrdzavejúcej ocele

Rukoväte potiahnuté PVC



Vysoká penosť a tvrdosť

■ ISO 8976

■ Mimoriadne odolné voči korózii"

7 nastaviteľných polôh

BAHCO	mm	mm	g	€
SS410-250	36	250	380	94,30
SS410-300	50	300	450	141,50

Bočné štiepacie kliešte z nehrdzavejúcej ocele



■ ISO 5749

■ Mimoriadne odolné voči korózii



Vysoká penosť a tvrdosť

Rukoväte potiahnuté PVC

BAHCO	mm	mm	mm	g	€
SS402-160	160	0.8*	0.8*	130	63,00
SS402-200	195	0.8*	0.8*	335	68,70

65I/7-1

Sada bitov z nehrdzavejúcej ocele

7

● 1/4" DIN 3126-C6.3, ISO 1173



⊕ PH2 ⊕ PZ2

⊕ T15 T20 T25 T30

● 1/4" ⊕ 1/4"



16,70 €

NÁRADIE PRE PRÁCU VO VÝŠKACH

Aby sa predišlo nehodám spôsobených padajúcim náradím pri prácach vo veľkých výškach, používa sa náradie s ochranou proti pádu.

Používanie takéhoto náradia zaručuje spoľahlivú ochranu pred pádom náradia a tým predchádza vážnym zraneniam, škodám na majetku alebo strate náradia. Značka Bahco vyvinula najlepšie riešenia pre prácu vo výškach pre každé náradie.

Bahco je členom skupiny DROPS (dropped objects prevention scheme), čo je priemyselná iniciatíva zameraná na prevenciu nehôd spôsobených padajúcimi predmetmi. Všetky naše riešenia náradia sú schválené podľa smerníc DROPS.



Systém detekcie farieb na určenie maximálnej nosnosti/hmotnosti



DROPS



Bahco Professionals:
Magnus Strömhall - Climber - YouTube



<https://youtu.be/Ci2F7dLXOLI>

3875-LY5
Závesné pútko



Systém detekcie farieb

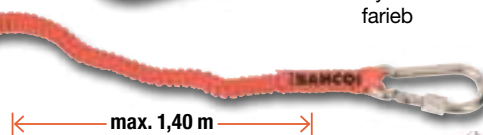

13,00 €

Kombinované kľúče s bezpečnostnou pružinou

■ Vysokokvalitná legovaná oceľ

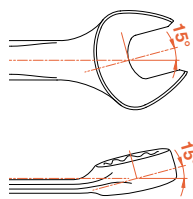

DYNAMIC-DRIVE™

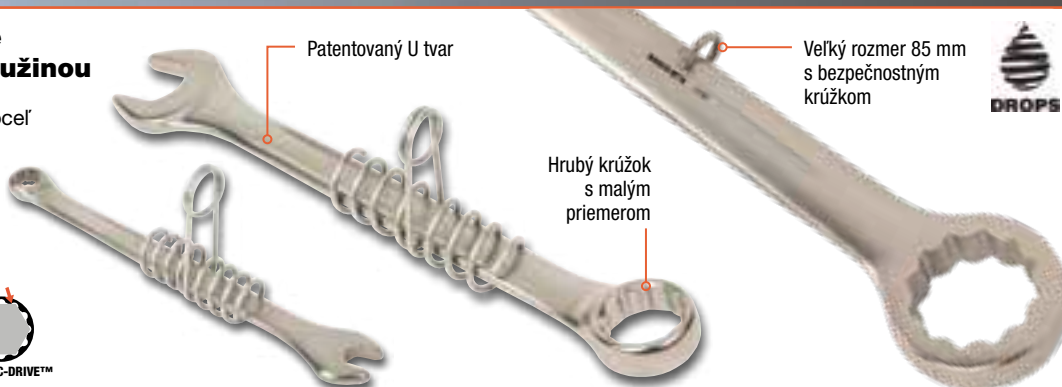

BAHCO	mm	mm	g	€
TAH111M-6	6	112	30	11,35
TAH111M-7	7	120	30	10,35
TAH111M-8	8	130	40	10,35
TAH111M-9	9	136	40	11,35
TAH111M-10	10	144	50	11,05
TAH111M-11	11	153	60	11,15
TAH111M-12	12	160	70	11,30
TAH111M-13	13	165	100	11,65
TAH111M-14	14	177	110	11,85
TAH111M-15	15	185	120	12,05
TAH111M-16	16	195	130	10,85
TAH111M-17	17	200	145	11,05
TAH111M-18	18	208	170	15,00
TAH111M-19	19	215	180	11,85
TAH111M-20	20	240	210	13,60

BAHCO	mm	mm	g	€
TAH111M-21	21	250	240	13,75
TAH111M-22	22	250	240	14,45
TAH111M-23	23	270	310	23,25
TAH111M-24	24	270	320	18,75
TAH111M-25	25	290	345	19,20
TAH111M-27	27	310	470	20,55
TAH111M-30	30	330	530	20,70
TAH111M-32	32	345	590	22,10
TAH111M-34	34	347	570	23,05
TAH111M-36	36	400	870	38,40
TAH111M-41	41	438	1130	53,05
TAH111M-46	46	500	1790	68,15
TAH111M-50	50	540	2200	88,40
TAH111M-55	55	560	2800	164,00
TAH111M-85	85	780	9370	553,00

Nastaviteľný kľúč ERGO™ s bezpečnostnou karabínkou



- Čierny povrch, presne kalené s protikoróznou úpravou
- Normy: ISO 9787, DIN 3117, ASME B107.8M - 1996 a BS 6333



BAHCO	mm	mm	mm	g	€
TAH9070	20	4,9	158	150	34,65
TAH9072	31	9	250	500	33,50

4750-HDLB-TAH Kožený opasok

39,70 €



- So 6 krúžkami na pripevnenie náradia a iných predmetov

4750-UP-2 Univerzálne puzdro



43,80 €

4 bezpečnostné krúžky na pripevnenie lanka

NÁRADIE PRE PRÁČU VO VÝŠKACH

Bočné štiepacie kliešte ERGO™ ergo® s bezpečnostným krúžkom

- ISO 5749
- Čierna povrchová úprava
- Ergonomické dvojzložkové rukoväte
- Vratná pružina s funkciou zapnutia/vypnutia



BAHCO	mm	Fe+ mm	g	€
TAH2101G-125	130	1.8	100	43,25
TAH2101G-140	145	2.0	140	43,25
TAH2101G-160	165	2.5	180	44,25
TAH2101G-180	185	2.7	245	44,35

Bočné štiepacie kliešte ERGO™ ergo® pre náročné aplikácie s bezpečnostným krúžkom

- ISO 5749
- Čierna povrchová úprava
- Vratná pružina
- Robustná strihacia hlava



BAHCO	mm	Fe+ mm	g	€
TAH21HDG-200	210	3.2	270	43,35

TAH481 Zámočnicke kladivo s bezpečnostnou drôtenou slučkou

- DIN 1041
- Prvotriedne jaseňové drevo



BAHCO	mm	g	€
TAH481	300	360	39,95

TAH8224 Kliešte s posuvným kíbom ERGO™ s bezpečnostným krúžkom

- ISO 8976
- Čierna povrchová úprava
- Ovládanie nastavenia jednou rukou
- Pohodlná 2-zložková rukoväť



BAHCO	mm	mm	g	€
TAH8224	45	250	360	41,95



KUFRE NA NÁRADIE

4750RCHDW02
Nerostbitný odolný kufor z polypropylénu na kolieskach s teleskopickou rukoväťou

630 x 480 x 290 mm



-33 °C - +90 °C



1.899,00 €



1.899,00 €

4750RCHDW02FF15

Sada náradia v odolnom kufri na údržbu veterných turbín

35



4750RCHDW02FF4

Sada náradia v odolnom kufri na všeobecnú údržbu veterných turbín

113



TAH1177-SCRIBE 230 mm	
TAHBE-8985 Ø + 2 mm	
TAHBE-8020L 0,5x3x7	
TAHBE-8030 0,6x3,5x7,5	
TAHBE-8155 1,2x6,5x125	
TAHBE-8280 1,6x8,0x175	
TAHBE-8610 PH1x75	
TAHBE-8620 PH2x100	
TAHBE-8630 PH3x150	
TAHBE-8610 PZ1x75	
TAHBE-8620 PZ2x100	
TAHBE-8630 PZ3x150	
TAHBE-8040S 0,8x4,0x100	
TAHBE-8050S 1,0x5,5x125	
BTAHE-8220S 0,5x3,0x100	
TAHBE-8610S PH1x80	
TAHBE-8620S PH2x100	
TAH111M-17 mm	
MTS-5-25 25 mm	
TAH16B 1/2" 10, 11, 12, 13, 14, 15, 16, 17, 18, 19, 21, 22, 24, 27, 30, 32 mm	

TAH3625W-35 Ø + 35 mm	
TAH481-300 300 g	
TAH2484-30 300 mm	
TAH3734BM-3, 5, 8 mm	
TAH3758BM-4 4 mm	
TAH6700SM-1/4" 5, 5, 6, 7, 8, 9, 10, 11, 12, 13 mm	
TAH6950 1/4"	
TAH6956 1/4" 150 mm	
TAH6958 1/4" 153 mm	
TAH6960 1/4" 50 mm	
TAH6961 1/4" 100 mm	
TAH6962 1/4" 150 mm	
TAH6962L 1/4" 355 mm	
TAH6966 1/4" 35 mm	
TAH16-H 1/2" 5, 6, 7, 8, 10, 12, 14, 17, 19 mm	
TAH16 1/2" T40, T45, T50, T55, T60	
TAH150-1/2 1/2"	
TAH158B-1 1/2" 390 mm	
TAH160 1/2" 125 mm	
TAH162 1/2" 250 mm	
TAH166 1/2" 72 mm	

TAH1-210-06-2-2 150 mm	
TAHE64520 60-160 mm	
TAH452-2 1/2"-5X12	
7452-7-5x12-13, 17, 19 mm	
TAH111M-34, 36, 50 mm	
TAH6070 158 mm	
TAH6072 257 mm	
TAH2820EF2 200 mm	
TAH150-12HP 150 mm	
TAH1544 0,03-0,10 mm	
TAH2335F2 1kg 4, 522 mm	
TAH2101G-160 160 mm	
TAH2427G-200 200 mm	
TAH2430G-200 200 mm	
TAH2628G-160 160 mm	
TAHSCB140G 145 mm	
TAH2509 525 mm	
TAH2224 250 mm	
TAH2047-0,8-4 0,8x4x100	
TAH2047PR-1 2 PH 1-2	
TAH111M, 6, 7, 8, 9, 10, 11, 12, 13, 14, 15, 16 mm	

TAHBE-977B 2,5, 3, 4, 5, 6, 8, 10 mm	
TAH111M-18, 19, 21, 22, 24, 27, 30, 32 mm	
TAH1177-SCRIBE 230 mm	
TAHBE-8985 Ø + 2 mm	
TAHBE-8020L 0,5x3x7	
TAHBE-8030 0,6x3,5x7,5	
TAHBE-8155 1,2x6,5x125	
TAHBE-8280 1,6x8,0x175	
TAHBE-8610 PH1x75	
TAHBE-8620 PH2x100	
TAHBE-8630 PH3x150	
TAHBE-8810 PZ1x75	
TAHBE-8820 PZ2x100	
TAHBE-8830 PZ3x150	
TAHBE-8640S 0,8x4,0x100	
TAHBE-8050S 1,0x5,5x125	
BTAHE-8220S 0,5x3,0x100	
TAHBE-8610S PH1x80	
TAHBE-8620S PH2x100	
TAH111M-17 mm	

TAH3625W-35 Ø + 35 mm	
TAH481-300 300 g	
TAH2484-30 300 mm	
TAH3734BM-3, 5, 8 mm	
TAH3758BM-4 4 mm	
TAH6700SM-1/4" 5, 5, 6, 7, 8, 9, 10, 11, 12, 13 mm	
TAH6950 1/4"	
TAH6956 1/4" 150 mm	
TAH6958 1/4" 153 mm	
TAH6960 1/4" 50 mm	
TAH6961 1/4" 100 mm	
TAH6962 1/4" 150 mm	
TAH6962L 1/4" 355 mm	
TAH6966 1/4" 35 mm	
MTS-5-25 25 mm	
TAH16B 1/2" 10, 11, 12, 13, 14, 15, 16, 17, 18, 19, 21, 22, 24, 27, 30, 32 mm	
TAH16 1/2" 5, 6, 7, 8, 10, 12, 14, 17, 19 mm	
TAH16 1/2" T40, T45, T50, T55, T60	
TAH150-1/2 1/2"	
TAH158B-1 1/2" 390 mm	
TAH160 1/2" 125 mm	
TAH162 1/2" 250 mm	
TAH166 1/2" 72 mm	

NEISKRIVÉ NÁRADIE

Neiskrivé náradie sa používa v oblastiach, kde sa nachádzajú horľavé alebo vysoko horľavé výpary, kvapaliny alebo prach, ako aj v prostredí, kde existuje riziko požiaru a výbuchu.

Neiskrivé náradie značky Bahco je vyrobené z hliníkového bronzu alebo meď-berýlia, ktoré výrazne znižujú riziko zapálenia iskier.



2-zložková
rukoväť zo
sklolaminátu

Dielenské kladivo, neiskrivé

- Sklolaminátová rukoväť
- Hliníkový bronz
- DIN 1041

BAHCO	↔ mm	Ø mm	↕ g	↕ g	€
NS504-100-FB	280	16	100	220	45,95
NS504-200-FB	280	22	200	320	45,95
NS504-300-FB	280	23	300	420	49,00
NS504-500-FB	310	28	500	700	51,90
NS504-800-FB	340	32	800	1030	95,30
NS504-1000-FB	960	50	1000	2170	95,30
NS504-1500-FB	400	40	1500	1850	146,00
NS504-2000-FB	395	45	2000	2270	185,00

NS408-250



Rukoväť
potiahnuté PVC

Kliešte s posuvným kĺbom, neiskrivé

- Hliníkový bronz
- ISO 8976

BAHCO	↕ mm	↔ mm	↕ g	€
NS408-250	45	250	400	144,30

Kombinované klúče, neiskrivé

- Hliníkový bronz
- ISO 3113

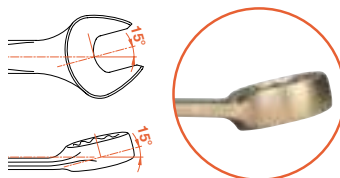

BAHCO	mm	mm	g	€
NS002-6	6	105	16	18,20
NS002-7	7	120	30	20,40
NS002-8	8	120	40	23,10
NS002-9	9	135	42	26,50
NS002-10	10	135	42	28,65
NS002-11	11	150	60	30,75
NS002-12	12	150	60	33,25
NS002-13	13	175	82	34,50
NS002-14	14	175	82	34,95
NS002-15	15	195	140	36,70
NS002-16	16	195	125	38,80
NS002-17	17	195	130	40,10
NS002-18	18	215	165	41,85
NS002-19	19	215	165	42,70
NS002-20	20	215	165	45,75
NS002-21	21	245	260	50,15
NS002-22	22	245	250	52,35
NS002-23	23	265	310	56,95
NS002-24	24	265	290	61,20
NS002-25	25	265	280	68,70
NS002-26	26	290	430	76,20
NS002-27	27	290	410	87,50
NS002-28	28	290	410	97,50
NS002-29	29	320	635	100,20
NS002-30	30	320	580	106,30
NS002-31	31	340	710	133,40
NS002-32	32	340	690	144,95
NS002-33	33	340	690	144,95
NS002-34	34	360	860	144,95
NS002-35	35	360	910	150,40
NS002-36	36	360	880	154,90
NS002-38	38	430	1310	177,75
NS002-40	40	430	1190	200,60
NS002-41	41	430	1230	205,00
NS002-42	42	430	1150	227,90
NS002-46	46	480	1590	227,90
NS002-50	50	520	1830	264,35
NS002-52	52	520	1830	273,50
NS002-55	55	560	2270	282,60
NS002-60	60	595	2640	309,90
NS002-65	65	595	3110	355,55
NS002-70	70	630	3730	391,95
NS002-75	75	630	3620	501,40
NS002-80	80	660	4880	592,60



Nastaviteľné klúče, neiskrivé

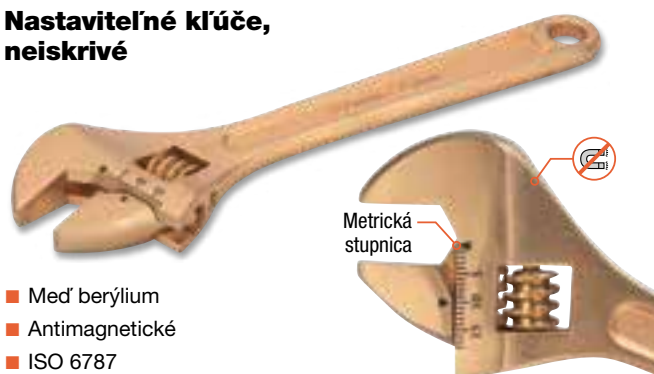

- Meď berýlium
- Antimagnetické
- ISO 6787

BAHCO	mm	mm	g	€
NSB001-150	18	150	135	102,80
NSB001-200	24	200	290	121,40
NSB001-250	30	250	500	146,75
NSB001-300	36	300	830	205,70
NSB001-375	48	375	1550	331,80
NSB001-450	55	450	2261	451,80
NSB001-600	65	600	4990	813,20
NSB001-900	75	900	10000	1.708,00

Skrutkovač ERGO™ pre skrutky s drážkou Phillips, neiskrivé

ergo®

- Hliníkový bronz
- ISO 8764



BAHCO	mm	mm	mm	€
NS302-0-50	⊕ PH 0 x 50	20 x 122	170	32,20
NS302-1-100	⊕ PH 1 x 100	20 x 122	220	36,95
NS302-2-125	⊕ PH 2 x 125	27 x 122	250	39,85
NS302-3-150	⊕ PH 3 x 150	36 x 122	270	45,95
NS302-4-300	⊕ PH 4 x 300	36 x 122	320	71,10

IZOLOVANÉ SADY NÁRADIA

Všetko Bahco izolované náradie sa vyrába podľa medzinárodných noriem IEC 60900 a je vhodné pre prácu na zariadeniach pod napätím do 1000 V striedavého a 1500 V jednosmerného prúdu. Podlieha prísnyh kontrolám kvality a prechádza prísnyh skúškami.

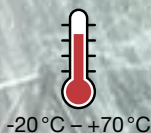

IEC 60900  1000 V 

- ▶ Vysoko výkonný a vysoko kvalitný materiál
- ▶ Žiadne šírenie plameňov
- ▶ Použitie pri: -20° C až +70° C



Čierny koniec chráni pred nárazmi



-  = Bezpečné
-  = Nebezpečné
-  = Vysoké riziko

Na zabezpečenie bezpečnosti pri práci na zariadeniach pod napätím sa každý jeden kus testuje pod napätím 10 000 voltov počas 10 sekúnd.

6MV/10T

Sada vidlicových kľúčov s máčanou izoláciou

IEC 60900  1000 V 

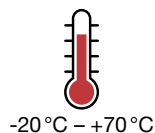

- 3-vrstvový izolačný povlak rôznych farieb



 mm 10 11 12 13 14 16 17 18 19 22



242,95 €

IEC 60900  1000 V 



7811DMV Sada izolovaných nástrčných klúčov

11

 1/2"

- 3-vrstvový izolačný povlak rôznych farieb*
- Kufřík z nárazuvzdorného plastu

369,00 €

 320 x 300 x 100 mm



-20°C – +70°C

 10 11 13 17 19 20 22 *	
 1/2" Račňa*	
 1/2" T-rukoväť*	
 1/2" Predlžovací nástavec*	
 1.0 x 5.5 x 125	

IEC 60900  1000 V 



3045V-2 Sada izolovaného náradia, pre elektrikárov

19

 1/2"

- 3-vrstvový izolačný povlak rôznych farieb*
- Kožený kufřík s kovovými výstuhami

369,00 €

 430 x 260 x 160 mm



-20°C – +70°C

Bočné štiepacie kliešte* 160 mm	
Kombinované kliešte* 180 mm	
Kliešte s kruhovými čelustami* 160 mm	
Odizolovacie kliešte* 160 mm	
Vidlicové klúče* 10 11 12 13 14 17 19 mm	
 0.5x3.0 1.0x5.5 0.8x4.0 1.2x6.5	
 PH1 PH2	
Elektrikársky nôž*	
Elektrikárske nožnice	

IZOLOVANÉ SKRUTKOVÁČE DO 1000 V

Izolované skrutkovače ERGO™ pre skrutky s rovnou drážkou

ergo®

1000 V

Podľa IEC 900, DIN EN 60900, VDE 0682 časť 201



BAHCO				€
BE-8010S	⊖ 0.4 x 2.5 x 75	20 x 122	197	4,80
BE-8220S	⊖ 0.5 x 3.0 x 100	20 x 122	222	4,10
BE-8230S	⊖ 0.6 x 3.5 x 100	20 x 122	222	5,15
BE-8040S	⊖ 0.8 x 4.0 x 100	20 x 122	222	5,15
BE-8050S	⊖ 1.0 x 5.5 x 125	27 x 122	247	6,15
BE-8065S	⊖ 1.2 x 8.0 x 175	36 x 122	297	10,15

Maximálny komfort s minimálnym úsilím vďaka ergonomickému dizajnu



BE-9881SL

Sada skrutkovačov ERGO™ s úzkou čepeľou, izolovaných

ergo® 1000 V

Podľa IEC 900, DIN EN 60900, VDE 0682 časť 201

ÚZKA ČEPEĽ

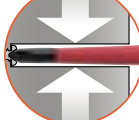

O 30% užšie ako bežné čepele



5

 0.5 x 3.0 mm 1.0 x 5.5 mm
0.8 x 4.0 mm

 PH1
PH2

19,95 €

Izolované skrutkovače ERGO™ pre skrutky s drážkou Phillips®

ergo®

1000 V

Podľa IEC 900, DIN EN 60900, VDE 0682 časť 201



BAHCO				€
BE-8600S	⊕ PH 0 x 75	20 x 122	197	4,50
BE-8610S	⊕ PH 1 x 80	27 x 122	202	5,45
BE-8620S	⊕ PH 2 x 100	36 x 122	222	7,45
BE-8630S	⊕ PH 3 x 150	36 x 122	272	10,35

Izolované skrutkovače ERGO™ pre skrutky s drážkou Pozidriv®

ergo®

1000 V

Podľa IEC 900, DIN EN 60900, VDE 0682 časť 201



BAHCO				€
BE-8810S	⊕ PZ 1 x 80	27 x 122	202	6,00
BE-8820S	⊕ PZ 2 x 100	36 x 122	222	8,10
BE-8830S	⊕ PZ 3 x 150	36 x 122	272	13,65

Izolované skrutkovače ERGO™ pre skrutky s drážkou Torx®

ergo®

1000 V

Podľa IEC 900, DIN EN 60900, VDE 0682 časť 201



BAHCO				€
BE-8908S	⊕ T 8 x 75	20 x 122	197	6,65
BE-8909S	⊕ T 9 x 75	20 x 122	197	6,55
BE-8910S	⊕ T 10 x 100	20 x 122	222	5,70
BE-8915S	⊕ T 15 x 125	27 x 122	247	4,80
BE-8920S	⊕ T 20 x 125	27 x 122	247	5,90
BE-8925S	⊕ T 25 x 150	27 x 122	272	6,10

BE-9876S
Sada XXL izolovaných skrutkovačov ERGO™

ergo®  1000 V 

14

38,50 €



- Vyrobené podľa normy IEC 900, DIN EN 60900, VDE 0682 časť 201
- Ergonomická 3-zložková rukoväť



Kombinovaná drážka
Křížová drážka PZ1 5 mm
Křížová drážka PZ2 6 mm



PZ1
PZ2



PH1
PH2



T10
T15
T20



0.4x2.5 mm 0.8x4.0 mm
0.5x3.0 mm 1.0x5.5 mm
0.6x3.5 mm

ÚZKA ČEPEL

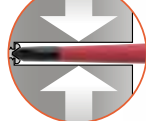

O 30% užšie ako bežné čepele

808061 / 808062
Izolovaná rukoväť račňových skrutkovačov so 6 izolovanými vymeniteľnými čepeľami v sade



100 mm

- Račňový mechanizmus so 48 zubami pre rýchle utáhovanie
- Dodáva sa v praktickom puzdre so 6 čepeľami a pútkom na opasok



Nevodivý krúžok, rýchla zmena polohy račňového mechanizmu

Bahco dizajn: mäkká protišmyková rukoväť pre pohodlné uchopenie

Patentované: tlačidlo na uvoľnenie a výmenu čepele

808061



808062



7

7

BAHCO					€	
808061	⊖	0.4x2.5	0.5x3.0	0.8x4.0	1.0x5.5	76,10
	⊕	PH1	PH2			
808062	⊖	0.4x2.5	0.5x3.0	0.8x4.0	1.0x5.5	76,10
	⊕	PZ1	PZ2			

MOMENTOVÉ NÁRADIE

74WR-

Nastaviteľný momentový klikací kľúč so stupnicou v okienku

- Robustný mechanizmus – po viac ako 100 000 cykloch v tolerancii $\pm 3\%$
- Pevná račňová hlava

Lahko čitateľná
dvojitá stupnica

Zvukový a hmatový signalizačný
systém pri kliknutí



Odolný voči:
benzín, olej, masnota

Označenie stredu rukoväte
pre optimálne uchopenie

Intervaly
opakovania
kalibrácie



BAHCO	Nm	mm	mm	g	€
74WR-15	3–15	1/4"	221	300	109,00
74WR-25	5–25	1/4"	221	300	109,00

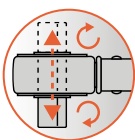

- Priechodný štvorhran na
zmenu smeru otáčania



BAHCO	Nm	ft.lb	mm	mm	g	€
74WR-50	10–50	7.5-37.5	3/8"	335	700	109,00
74WR-100	20–100	15-75	1/2"	387	900	112,00
74WR-200	40–200	30-150	1/2"	470	1100	115,00
74WR-300	60–300	45-220	1/2"	593	1400	125,00
74WR-340	60–340	45-250	1/2"	685	1500	125,00
74WR-400	80–400	60-300	3/4"	686	1900	199,00

Pohodlný na
dotyk príjemný
povrch



Odolný voči:
benzín, olej, masnota



Tlačidlo na nastavenie
krútiaceho momentu,
zreteľne viditeľné pri
uvolnení

74PR-

Prednastavený mechanický momentový kľúč

- Robustný mechanizmus – po viac ako 100 000 cykloch v tolerancii $\pm 3\%$
- Pevná račňová hlava



BAHCO	Nm	mm	mm	g	€
74PR-20	4–20	1/4"	219	400	109,00

Reverzibilná 1/4" račňová hlava na zmenu smeru otáčania

Špeciálny tvar rukoväte pre presné uchopenie



Zvukový a hmatový signalizačný systém pri kliknutí

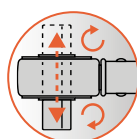

Priechodný štvorhran na zmenu smeru otáčania



BAHCO	Nm	mm	mm	g	€
74PR-60	12–60	3/8"	295	600	109,00
74PR-60A	12–60	1/2"	301	700	109,00
74PR-100	20–100	3/8"	335	700	115,00
74PR-100A	20–100	1/2"	342	700	115,00

Farebné kódy koncovky



BAHCO	Nm	mm	mm	g	€
74PR-200	40–200	1/2"	425	1000	125,00
74PR-300	60–300	1/2"	668	1200	129,00
74PR-400	80–400	3/4"	675	2000	149,00

75R3-

Nastaviteľný momentový klikací kľúč bez fixného bodu na rukoväti

- Konštantný krútiaci moment pri každej dĺžke páky
- Predĺžovacia rukoväť výrazne znižuje úsilie potrebné pre vysoké krútiace momenty
- Pevná račňová hlava

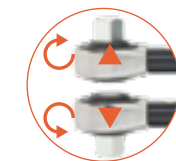

Priechodný štvorhran na zmenu smeru otáčania

Zvukový a hmatový signalizačný systém pri kliknutí



Lahko čitateľná dvojité stupnica

Uzamknutie rukoväte



Robustné kovové puzdro

Predĺženie pre väčší výkon



BAHCO	Nm	mm	mm	g	€
75R3-650*	130–650	3/4"	856	4000	749,00
75R3-800	200–800	3/4"	1037	5200	829,00
75R3-1000	300–1000	3/4"	1245	5800	899,00

* Predĺžovacia rukoväť nie je súčasťou dodávky, samostatne k dispozícii



MOMENTOVÉ NÁRADIE

Elektronický momentový kľúč s nastavovaním uhla ťahovania

- Programovateľný čas automatického vypnutia
- Uchovanie hodnôt a nastavení počas výmeny batérie



- Pevná račňová hlava s kĺbom, 40 zubov

- LED diódy na oboch stranách



- Dosiahol sa prah predbežného varovania
- V cieľovom rozsahu
- Mimo toleranciu

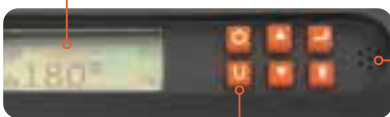

- Nm, Kg.cm., dNm, Lbf.ft., Lbf.in.



- Vibrovanie rukoväte

TAW- Elektronický momentový kľúč s nastavovaním uhla ťahovania

- 50 meraní
- 10 prednastavení

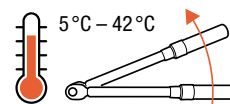

- Prevádzkové režimy:
 - Krútiaci moment
 - Uhol
 - Krútiaci moment a potom uhol
 - Prednastavené hodnoty

BAHCO	Nm	mm	mm	g	€
TAW38135	7-135	3/8"	475	1270	529,00
TAW12340	17-340	1/2"	670	1910	569,00
TAW34800	40-800	3/4"	1235	4850	999,00

TAWM- Elektronický momentový kľúč s nastavovaním uhla ťahovania s pamäťou & USB

- 1500 meraní
- 50 prednastavení

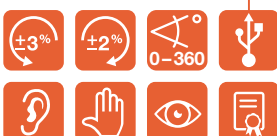

- Prevádzkové režimy:
 - Krútiaci moment
 - Uhol
 - Krútiaci moment a uhol
 - Krútiaci moment a potom uhol
 - Prednastavené hodnoty
 - Pracovný režim

BAHCO	Nm	mm	mm	g	€
TAWM38135	7-135	3/8"	475	1280	829,00
TAWM12340	17-340	1/2"	670	1970	889,00
TAWM34800	40-800	3/4"	1235	4850	1.299,00

TAWM1412M/TAWM1430M Elektronický Mikro-momentový kľúč s nastavovaním uhla ťahovania s pamäťou & USB

- 1500 meraní
- 50 prednastavení



- Prevádzkové režimy:
 - Krútiaci moment
 - Uhol
 - Krútiaci moment a uhol
 - Krútiaci moment a potom uhol
 - Prednastavené hodnoty
 - Pracovný režim

BAHCO	Nm	mm	mm	g	€
TAWM1412M	0.6-12	1/4"	292	405	699,00
TAWM1430M	1.5-30	1/4"	357	820	699,00

TAS14- Elektronický momentový skrutkovač

- Odolný a pevný kryt z kompozitného materiálu Tri-Lobe
- Membránová klávesnica s blokovacím tlačidlom, proti náhodnému prenasadeniu
- Prevádzkové režimy:
 - Krútiaci moment
 - Uhol
 - Krútiaci moment a potom uhol



BAHCO	Nm	cNm	□	○	← mm →	mm	g	€
TAS14H09	0.45-9	45-900	-	1/4"	189	40	325	629,00
TAS14S09	0.45-9	45-900	1/4"	-	189	40	325	629,00



89049TM-1000 Násobič krútiaceho momentu

- Vymeniteľné rovné a vyhnuté reakčné ramená

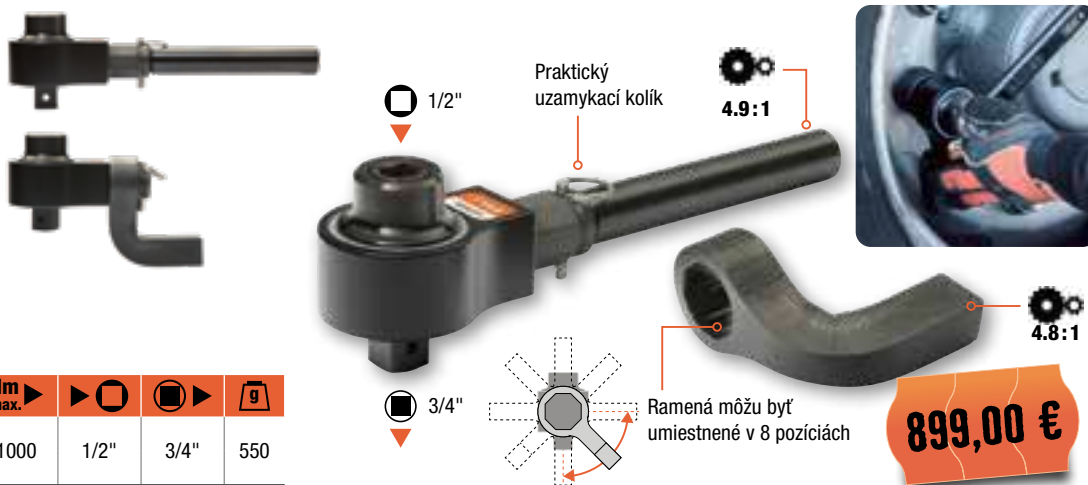

Nm max.	⚙️	Nm max.	▶ □	▶ ○	g
204	4.9:1	1000	1/2"	3/4"	550
208	4.8:1				

89222CR/96255CR Kompaktné násobiče krútiaceho momentu

- S vyhnutým reakčným ramenom
- Lahký kompaktný dizajn pre ľahký prístup



BAHCO	▶ Nm max.	⚙️	Nm max.	▶ □	▶ ○	g	€
89222CR-1000	45	22.2:1	1000	1/2"	3/4"	1400	1.795,00
9527CR-2000	74	27:1	2000	1/2"	1"	3200	1.895,00
9525CR-4000	160	25:1	4000	1/2"	1"	5400	3.150,00
96255CR-7000	274	25.5:1	7000	1/2"	1 1/2"	9300	3.750,00

AKUMULÁTOROVÉ NÁRADIE

Kovové puzdro
pre dlhšiu životnosť
a výkon



HDI



Všetky sady sa dodávajú
v plastovom kufri
s 2 akumulátormi a nabíjačkou

Nový sortiment pre
náračných mechanikov

BCL31IS1K1

Aku Mini rázový skrutkovač - sada

1/4"

155 mm

12V

max.
105
Nm



245,00 €

Rýchlopínacie
skrutčovač

0.93
kg

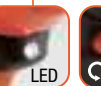

IP20



Video
BCL31IS1



- Kovové puzdro pre dlhšiu životnosť a výkon
- Nízke vibrácie vďaka dvojzložkovej rukoväti



1/4"	V	Max Nm	min ⁻¹	dba	m/sec ⁻²	mm	kg
1/4"	12	105	0-2400	101.1	8.85	155x50x191	0.93

BCL33IW1K1

Aku rázový ťahovák - sada

1/2"

18V

2 rýchlosti
110 Nm (550 RPM) + 590 Nm (1650 RPM)

575,00 €

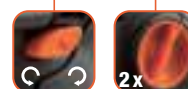

IP20

- Kovové puzdro pre dlhšiu životnosť a výkon
- Indikátor stavu akumulátora sa aktivuje vypínačom



1/2"	V	Max Nm	min ⁻¹	dba	m/sec ⁻²	mm	kg
1/2"	18	105 / 590	550 / 0-1650	99.2	6.65	260x70x258	3.11

BCL31D1K1 Aku vrtáčka/skrutkovač - sada

3/8"-10 mm

12V

Rýchlopínacie
skľúčovadlo

10 rôznych nastavení
krútiaceho
momentu
1 nastavenie vrtania

1.03
kg

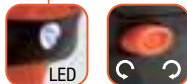

2 rýchlosti



235,00 €

Nízke vibrácie vďaka
dvojzložkovej rúkoväti

mm	V	Max Nm	min-1	dba	m/sec-2	mm	kg
10	12	24	360 / 1550	83.9	4.00	200x54x191	1.03



BCL32G1K1 Aku maznica - sada

14.4V

360,00 €

750
mm



≥ 400 g
414 bar
70g / min.

V	PSI / BAR	g/min.	dba	m/sec-2	mm	kg
14.4	600 / 414	70	78.6	0.39	200x75x485	3.4

BCL33D1K1 Aku vrtáčka/skrutkovač - sada

1/2"-13 mm

18V

Rýchlopínacie
skľúčovadlo

10 rôznych nastavení
krútiaceho
momentu
1 nastavenie vrtania

LED



2 rýchlosti



399,00 €

Nízke vibrácie vďaka
dvojzložkovej rúkoväti
Indikátor stavu akumulátora
sa aktivuje vypínačom

BEZUHLÍKOVÝ MOTOR

- ✓ vysoký krútiaci moment
- ✓ vyššia frekvencia úderov
- ✓ menšia údržba
- ✓ dlhšia životnosť

mm	V	min-1	Max Nm	dba	mm	kg
13	18	0-370 / 0-1570	32	83.5	180x60x290	1.35



AKUMULÁTOROVÉ NÁRADIE

BCL33IW2K1

Aku rázový uťahovák - sada



1/2"

18V

max. 1000 Nm

HD

IP20



BEZUHLÍKOVÝ MOTOR



- ✓ vysoký krútiaci moment
- ✓ vyššia frekvencia úderov
- ✓ menšia údržba
- ✓ dlhšia životnosť



665,00 €

- Vysoká efektívnosť, vynikajúci výkon
- Kovové puzdro pre dlhšiu životnosť a výkon

1/2"	V	Max Nm	min-1	dba	m/sec ²	mm	kg
1/2"	18	1000	0-1700	100.6	6.37	240x65x360	3.1



AKUMULÁTOROVÉ NÁRADIE

BCL33AP1K1

Aku excentrická brúska - sada

∅ 5"/127 mm Velcro®

18V



IP20

519,00 €

- Dodáva sa so špongiou a vlneným návlakom na čistenie a leštenie
- S bezpečnostným vypínačom
- Aretačné tlačidlo vypínača pre vyšší komfort práce
- Nízke vibrácie vďaka dvojzložkovej rukoväti

∅ mm	V	∅ mm		min-1	dba	m/sec ²	mm	kg
127	18	4.7	5/16" 24UNF	1100-3500	82.5	2.52	376x153	1.82



Indikátor stavu akumulátora



Aretačné tlačidlo s bezpečnostným vypínačom



• 1100
• 1450
• 2300
• 3050
• 3500
ot./min.

Pravo-/ľavostranná prídavná rukoväť pre lepšie ovládanie náradia



x1

x2

5 Ah

BITY A RAČŇOVÉ SKRUTKOVÁČE

59/S54BC Sada bitov

● 1/4" DIN 3126-C6.3, ISO 1173

54



<25mm>							<125mm>	<150mm>
4.5	PH1	PZ1	T10 x2	TR10	HEX3	R1	PH1	T20
5.5	PH2 x4	PZ2 x4	T15 x2	TR15	HEX4	R2	PH2	T25
	PH3	PZ3	T20 x4	TR20	HEX5			T30
	PH2G x2		T25 x2	TR25	HEX6		+	
			T27	TR30	HEX8			
			T30 x4					
			T40					

19,95 €

FAREBNÉ

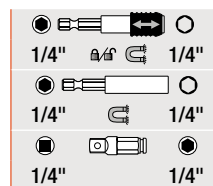
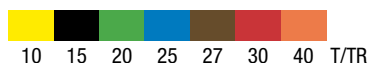

59/S100BC Sada bitov

● 1/4" DIN 3126-C6.3, ISO 1173

100



<25mm>						
4.5	PH1	PZ1 x2	T10 x3	TR10	HEX3	R1
5.5	PH2 x9	PZ2 x9	T15 x5	TR15	HEX4 x3	R2
	PH3	PZ3	T20 x15	TR20	HEX5	
	PH2G x5		T25 x8	TR25	HEX6 x3	
			T27	TR30	HEX8	
			T30 x15			
			T40 x3			

23,95 €

FAREBNÉ

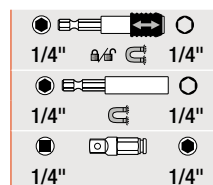
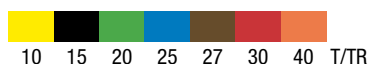

59/S31B Sada bitov

31

7,50 €



4.5	PH1	PZ1	T10	HEX3
5.5	PH2 x3	PZ2 x3	T15 x3	HEX4
	PH3	PZ3	T20 x3	HEX5
	PH2G x2		T25 x2	HEX6
			T27	
			T30	

● 1/4" DIN 3126-C6.3, ISO 1173



59S/22-2 Sada bitov

22

● 1/4" DIN 3126-C6.3, ISO 1173

■ V gumenom držiauku

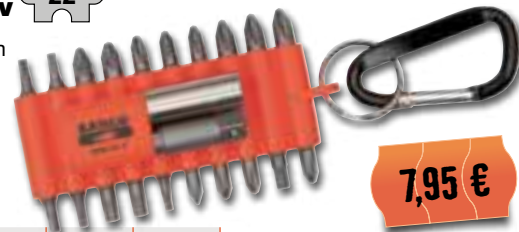

7,95 €

PH2 x3	PZ2 x2	T10	HEX2.5
PH2G x2	PZ3	T15 x4	HEX3.0
		T20 x3	
		T25 x2	

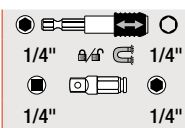



19,95 €

30°

808050P

Račňový skrutkovač, držiak bitov s pištoľovou rukoväťou

● 1/4" DIN 3126-C6.3, ISO 1173

- Stlačením tlačidla sa rukoväť otočí a zablokuje v polohe 30°
- So 6 bitmi v zásobníku v rukoväti

⊖	⊕	⊕
0.6x4.5	PH1	PZ1
0.8x5.5	PH2	PZ2



808050L

Račňový skrutkovač, držiak bitov s LED osvetlením

● 1/4" DIN 3126-C6.3, ISO 1173

- So 6 bitmi v zásobníku v rukoväti

19,95 €

⊖	⊕	⊕
0.6x4.5	PH1	PZ1
0.8x5.5	PH2	PZ2



808050S

Račňový skrutkovač, držiak bitov, krátky

● 1/4" DIN 3126-C6.3, ISO 1173

- Pre prácu v stiesnených priestoroch

13,95 €



KM653-QR-1P

Magnetický držiak bitov



5,55 €

○	●
1/4"	1/4"

2058/S26

Sada bitov, nástrčných kľúčov, račňového kľúča a adaptérov

- Vďaka patentovanému 1/4" račňovému kľúču (US Pat. 6860175) sa dajú skrutky a matice ľahko uvoľniť a utiahnuť aj v stiesnených priestoroch

19,95 €

26

8 mm 1/4"

⊖	⊕	⊕	⊕	●	○
4.0	PH1	PZ1	T10	3	6
5.0	PH2	PZ2	T15	4	7
6.0	PH3	PZ3	T20	5	8
			T25	6	10
			T30		13

1/4" 1/4" 1/4" 1/4" 1/4"



SKRUTKOVAČE

Skrutkovače ERGO™ pre skrutky s rovnou drážkou

ergo®

- BE-8160 so šesťhranom pre použitie vidlicového kľúča na zvýšenie krútiaceho momentu



BAHCO					€
BE-8010	⊖ 0.4 x 2.5 x 60	20 x 122	182	-	2,95
BE-8030	⊖ 0.6 x 3.5 x 75	20 x 122	197	-	3,55
BE-8040	⊖ 0.8 x 4.0 x 100	20 x 122	222	-	4,10
BE-8150	⊖ 1 x 5.5 x 100	27 x 122	222	-	5,45
BE-8155	⊖ 1.2 x 6.5 x 125	36 x 122	247	-	6,50
BE-8160	⊖ 1.6 x 8 x 125	36 x 122	247	14	10,60

Skrutkovače ERGO™ pre skrutky s drážkou Phillips®

ergo®

- BE-8630 so šesťhranom pre použitie vidlicového kľúča na zvýšenie krútiaceho momentu

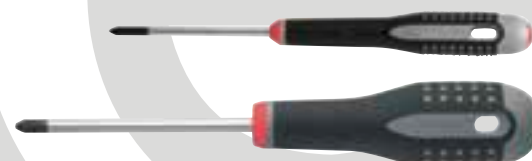

BAHCO					€
BE-8600	⊕ PH 0 x 60	20 x 122	182	-	3,90
BE-8610	⊕ PH 1 x 75	27 x 122	197	-	4,95
BE-8620	⊕ PH 2 x 100	36 x 122	222	-	6,75
BE-8630	⊕ PH 3 x 150	36 x 122	272	14	15,25

Skrutkovače ERGO™ pre skrutky s drážkou Pozidriv®

ergo®

- BE-8830 so šesťhranom pre použitie vidlicového kľúča na zvýšenie krútiaceho momentu



BAHCO					€
BE-8800	⊕ PZ 0 x 60	20 x 122	182	-	4,80
BE-8810	⊕ PZ 1 x 75	27 x 122	197	-	5,60
BE-8820	⊕ PZ 2 x 100	36 x 122	222	-	7,35
BE-8830	⊕ PZ 3 x 150	36 x 122	272	14	11,00



Ergonomické skrutkovače Plusy sú vo vašej ruke

- 1 Trvalé farebné označenie pre výber správneho typu čepele
- 2 Optimálna dĺžka rukoväte s rýchlou zónou otáčania
- 3 Trojzložková rukoväť: masívne jadro s protišmykovým povrchom
- 4 Zaoblené hrany zabraňujú vzniku tlakových bodov
- 5 Mäkký, protišmykový povrch
- 6 Plochá časť zabraňuje odkotúľaniu

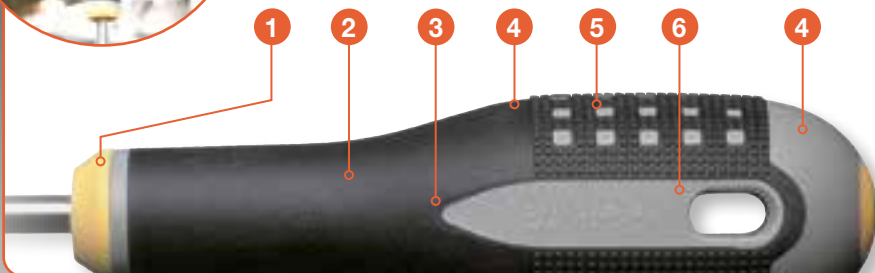

ergo®

Skrutkovače ERGO™ pre skrutky s vnútorným šesťhranom

ergo®

- Guľový tvar hrotu pre lepší prístup

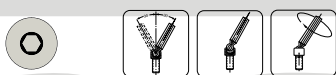

BAHCO	mm	mm	mm	€
BE-8715	● H 1.5 x 60	20 x 122	182	4,05
BE-8702	● H 2 x 100	20 x 122	222	4,00
BE-8725	● H 2.5 x 100	20 x 122	222	4,10
BE-8703	● H 3 x 100	20 x 122	222	4,25
BE-8704	● H 4 x 100	27 x 122	222	4,90
BE-8705	● H 5 x 100	36 x 122	222	6,05
BE-8706	● H 6 x 125	36 x 122	247	7,00
BE-8708	● H 8 x 150	36 x 122	272	10,30

Skrutkovače ERGO™ pre skrutky s drážkou Torx®

ergo®



BAHCO	mm	mm	mm	€
BE-8904	⊕ T 4 x 75	20 x 122	197	4,55
BE-8905	⊕ T 5 x 75	20 x 122	197	4,55
BE-8906	⊕ T 6 x 75	20 x 122	197	4,55
BE-8907	⊕ T 7 x 75	20 x 122	197	4,55
BE-8908	⊕ T 8 x 75	20 x 122	197	4,60
BE-8909	⊕ T 9 x 75	20 x 122	197	4,60
BE-8910	⊕ T 10 x 75	20 x 122	197	3,55
BE-8915	⊕ T 15 x 100	27 x 122	222	4,80
BE-8920	⊕ T 20 x 100	27 x 122	222	5,85
BE-8925	⊕ T 25 x 125	27 x 122	247	6,25
BE-8930	⊕ T 30 x 150	36 x 122	272	6,30

Skrutkovače ERGO™ pre skrutky s drážkou Torq-Set®



ergo®



BAHCO	mm	mm	mm	€
BE-8080-1	⊕ 1 x 75	27 x 122	197	14,85
BE-8080-2	⊕ 2 x 75	27 x 122	197	15,20
BE-8080-3	⊕ 3 x 75	27 x 122	197	15,20
BE-8080-4	⊕ 4 x 75	27 x 122	197	15,20
BE-8080-5	⊕ 5 x 75	27 x 122	197	15,20
BE-8080-6	⊕ 6 x 75	27 x 122	197	15,20
BE-8080-8	⊕ 8 x 100	27 x 122	222	21,35
BE-8080-10	⊕ 10 x 100	27 x 122	222	21,35

BE-3529 ERGO™ páka s očkom

ergo®

- Na odpájanie



BAHCO	mm	mm	mm	€
BE-3529	3 x 175	20 x 122	175	11,75

SKRUTKOVAČE

BE-9877

Sada XXL skrutkovačov ERGO™

■ Ergonomická 3-zložková rukoväť

ergo®



NOVINKA

37,95 €

15



0.6x3.5x75 mm
1.0x5.5x100 mm



PH1 x75 mm
PH2 x100 mm



PZ1 x75 mm
PZ2 x100 mm



T10x75 mm
T15x100 mm
T20x100 mm
T25x125 mm

Izolované 1000 V skrutkovače

Podľa IEC 900,
DIN EN 60900,
VDE 0682 časť 201

1000 V



0.5x3.0x100 mm
0.8x4.0x100 mm
1.0x5.5x125 mm



PH1 x80 mm
PH2 x100 mm

Sady skrutkovačov s T-rukoväťou



Dlhá čepeľ umožňuje dosiahnutie stredného krútiaceho momentu pri práci na neprístupných miestach



Krátku 90° čepeľ je možné používať na skrútkovanie s extrémnym ťahovacím momentom v ľahko dostupných miestach alebo s obmedzenou výškou



2-zložková rukoväť



6

BAHCO			€
903T-1	● Vnútrošesthran	3, 4, 5, 6, 8, 10 mm	51,00
903T-2	★ TORX®	T10, T15, T20, T25, T30, T40	42,55
903T-3	○ Šesthran	5, 6, 7, 8, 10, 13 mm	64,25

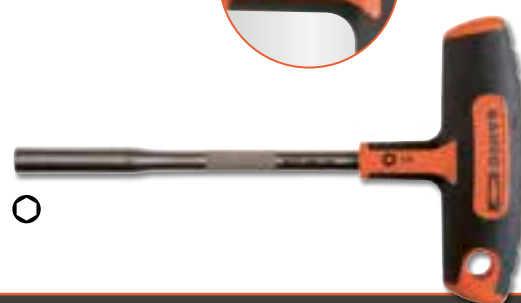

BE-9881TB

Sada skrutkovačov ERGO™ s priechodnou čepeľou



ergo®



29,95 €



0.6x3.5x75
0.8x4.5x100
1.0x5.5x100
1.2x6.5x125



PH1 x100
PH2x125

706-5

Sada presných skrutkovačov



- Otočná koncová krytka pre rýchle uťahovanie a uvoľňovanie
- Trvalé farebné označenie na rýchlu identifikáciu správneho profilu

⊖	⊕	⊕	⊕	⊕	⊕	⊕
1.0	2.0	PH00	PZ0	T6	T10	M 1.5
1.2	3.0	PH0	PZ1	T7	T15	M 2.0
1.5	3.5	PH1	PZ3	T8	T20	M 2.5
1.8	4.0			T9		M 3.0



125,00 €

Skúšačka napätia do 250 V

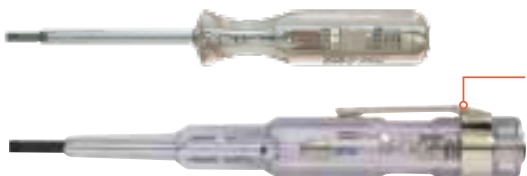

8045LVDE so sponou

- Plastová rukoväť odolná voči nárazom
- V súlade s normou DIN VDE 0680/6 GS-značené

BAHCO	⊖	mm	€
8045VDE	0.5x3.5	134	8,95
8045LVDE	0.5x3.5	170	8,95

RAČNE

Obojsmerné račne s úzkou hlavou

Tlačidlo pre rýchle uvoľnenie



Páčka pre rýchlu zmenu smeru

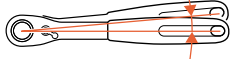

6950SL Obojsmerná račňa 1/4"

■ 72 zubov 

7750SL Obojsmerná račňa 3/8"

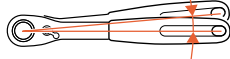
■ 72 zubov 

8150SL Obojsmerná račňa 1/2"

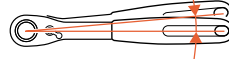
■ 72 zubov 

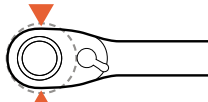
 Veľmi úzka hlava pre prácu v úzkych stiesnených priestoroch



BAHCO	Ø	∠	mm	g	€
6950SL	1/4"	5°	120	90	22,95
7750SL	3/8"	5°	205	200	27,95
8150SL	1/2"	5°	265	440	31,50

Račne s výkyvnou hlavou



■ 72 zubov 

NOVINKA



BAHCO	Ø	∠	mm	g	€
8120-1/4	1/4"	5°	149	129	17,95
8120-3/8	3/8"	5°	223	311	26,50
8120-1/2	1/2"	5°	266	572	32,95



Obojsmerné jednoručné račne ERGO™

7755-3/8 Obojsmerná račňa 3/8"

■ 72 zubov 



Integrovaný otočný krúžok pre jednoduchšiu zmenu smeru



Tlačidlo pre rýchle uvoľnenie



Rýchle otáčanie krúžku

8155-1/2 Obojsmerná račňa 1/2"

■ 60 zubov 

BAHCO	Ø	∠	mm	g	€
7755-3/8	3/8"	5°	215	245	47,75
8155-1/2	1/2"	6°	260	575	50,25

NÁSTRČNÉ KLÚČE

Adaptér



BAHCO	□	○	←mm→	€
K6650-1/4-1P	1/4"	1/4"	50	6,05
K6650-3/8-1P	3/8"	1/4"	60	6,85
K6650-1/2-1P	1/2"	1/4"	60	8,95

Nástrčný klúč s magnetom



BAHCO	○	○	€
KM6750-7	1/4"	7 mm	2,95
KM6750-8	1/4"	8 mm	2,95
KM6750-10	1/4"	10 mm	2,95
KM6750-13	1/4"	13 mm	2,95
KM6750-3/8	1/4"	3/8"	2,95

Sada nástrčných klúčov na koľajničke:

6713MH
Sada nástrčných klúčov 13

□ 1/4" 48,50 €

○ 4 4.5 5 5.5 6 7 8 9 10 11 12 13 14

6708DMB
Sada nástrčných klúčov, dlhých 7

□ 1/4" 38,60 €

○ 6 7 8 9 10 11 12 13 | ←mm→ | 50.6

7400SR/S12
Sada nástrčných klúčov 12

□ 3/8" 65,95 €

○ 8 9 10 11 12 13 14 15 16 17 18 19

7408MD
Sada nástrčných klúčov, dlhých 8

□ 3/8" 35,00 €

○ 8 10 11 12 13 14 17 19 | ←mm→ | 60-63

7400TORX-ER/S7
Sada nástrčných klúčov 7

□ 3/8" 60,40 €

○ E8 E10 E11 E12 E14 E16 E18

7409MR/S7
Sada nástrčných klúčov s výstupom 7

□ 3/8" 56,65 €

○ M3 M4 M5 M6 M7 M8 M10

7409TORX-TRR/S5
Sada nástrčných klúčov s výstupom 5

■ pre skrutky Torx® s poistným kolíkom 53,20 €

□ 3/8"

○ TR27 TR30 TR40 TR45 TR50

7810MH
Sada nástrčných klúčov 10

□ 1/2" 54,20 €

○ 10 11 13 14 15 16 17 19 21 22

7806MD
Sada nástrčných klúčov, dlhých 6

□ 1/2" 62,55 €

○ 10 13 14 17 19 22 | ←mm→ | 82.6

7807TE
Sada nástrčných klúčov 6

□ 1/2" 46,10 €

○ E10 E12 E14 E16 E18 E20 E24

7808HM
Sada nástrčných klúčov s výstupom 8

□ 1/2" 67,90 €

○ M4 M5 M6 M7 M8 M10 M12 M14

7809TO
Sada nástrčných klúčov s výstupom 8

□ 1/2" 96,95 €

○ T20 T25 T27 T30 T40 T45 T50 T55 T60

SADY NÁSTRČNÝCH KLÚČOV



24,00 €

SL25 Sada nástrčných klúčov 25

- 1/4"
- Metrické rozmery
- Vysoko výkonná legovaná oceľ, matný povrch
- ISO 1174/DIN 3120



Bahco Online-Katalóg >



○ 4 4.5 5 5.5 6 7 8 9 10 11 12 13
● 1/4" 60 zubov, uhol záberu 6°
● 1/4" 100 mm
○ 1/4" 1/4"
⊕ T10 15 20 25 30 40
● M 5 6 ⊕ PH 1 2



24,00 €

SL25AF Sada nástrčných klúčov 25

- 1/4"
- Palcové rozmery
- Vysoko výkonná legovaná oceľ, matný povrch
- ISO 1174/DIN 3120



Bahco Online-Katalóg >



○ 1/8" 5/32" 3/16" 7/32" 1/4" 9/32" 5/16" 11/32" 3/8" 7/16" 1/2" 9/16"
● 1/4" 60 zubov, uhol záberu 6°
● 1/4" 100 mm
○ 1/4" 1/4"
⊕ T10 15 20 25 30 40
● 7/32" 1/4" ⊕ PH 1 2



39,00 €

SL25L Sada nástrčných klúčov 37

- 1/4"
- Metrické rozmery
- S veľmi dlhými nástrčnými klúčmi
- Vysoko výkonná legovaná oceľ, matný povrch
- ISO 1174/DIN 3120



Bahco Online-Katalóg >



○ 4 4.5 5 5.5 6 7 8 9 10 11 12 13
○ 4 5 6 7 8 9 10 11 12 13
● 1/4" 60 zubov, uhol záberu 6°
● 1/4" 100 mm
○ 1/4" 1/4"
⊕ T10 15 20 25 30 40
● M 4 5 6 ⊕ PH2 x 2 ⊕ PZ2 x 2



49,95 €

S330 Sada nástrčných klúčov 34

- 1/4" + 3/8"
- Metrické rozmery
- Vysoko výkonná legovaná oceľ, matný povrch
- ISO 1174/DIN 3120



Bahco Online-Katalóg >



○ 10 11 12 13 14 15 16 17 18 19 20 22
○ 16 21
● 3/8" 60 zubov, uhol záberu 6°
● 3/8" 75 & 150 mm
● 3/8"
○ 3/8" 1/4"
● 1/4" 1/4"
● 1/4"
⊖ 4 5.5 7
⊕ PH 1 2 3 4
● M 3 4 5 6 7 8





79,95 €

S240
Sada nástrčných klúčov 24

- 1/2"
- Metrické rozmery
- Vysoko výkonná legovaná oceľ, matný povrch
- ISO 1174/DIN 3120



Bahco
Online-
Katalóg >



10	11	12	13	14	15	16	17	18	19	20	21	22	23	24	27	30	32
1/2"	60 zubov, uhol záberu 6°																
1/2"	250 mm																
1/2"	125 & 150 mm																
1/2"	&																



75,00 €

S240AF
Sada nástrčných klúčov 24

- 1/2"
- Metrické + Palcové rozmery
- Vysoko výkonná legovaná oceľ, matný povrch
- ISO 1174/DIN 3120



Bahco
Online-
Katalóg >



1/8"	3/8"	7/16"	1/2"	9/16"	5/8"	11/16"	3/4"	13/16"	7/8"	15/16"	1"	1.1/16"	1.1/8"	1.3/16"	1.1/4"		
5/8"	(16 mm) & 13/16" (21 mm)																
1/2"	60 zubov, uhol záberu 6°																
1/2"	250 mm																
1/2"	125 & 150 mm																
1/2"	&																



75,00 €

S330L
Sada nástrčných klúčov 53

- 1/4" + 3/8"
- Metrické rozmery
- ISO 1174/DIN 3120
- S veľmi dlhými nástrčnými klúčmi
- Vysoko výkonná legovaná oceľ, matný povrch



Bahco
Online-
Katalóg >



10	11	12	13	14	15	16	17	18	19	20	22						
10	11	12	13	14	15	17	18	19	20	22							
16	21																
3/8"	60 zubov, uhol záberu 6°																
3/8"	75 & 150 mm																
3/8"	&																
3/8"	1/4"																
1/4"	1/4"																
1/4"	&																
4	5	5	7														
PH 1	2	3	PZ 1	2													
M 2.5	3	4	5	6	7	8											
T10	T15	T20	T25	T30	T40												



94,00 €

S560
Sada nástrčných klúčov 56

- 1/4" + 1/2"
- Metrické rozmery
- ISO 1174/DIN 3120
- S 12-hrannými nástrčnými klúčmi
- Vysoko výkonná legovaná oceľ, matný povrch



Bahco
Online-
Katalóg >



4	4.5	5	5.5	6	7	8	9	10	11	12	13						
4	5	6	7	8	9	10	11	12	13								
1/4"	72 zubov, uhol záberu 5°																
1/4"	&																
1/4"	50 & 100 mm																
1/4"	&																
10	11	12	13	14	15	17	19	22	24	27	30	32					
16	21																
1/2"	72 zubov, uhol záberu 5°																
1/2"	250 mm																
1/2"	125 & 150 mm																
1/2"	&																
1/2"	5/16"																
1/4"	1/4"																
1/4"	1/4"																
5/16"	T45 T50 T55																
1.5	2	2.5															

SADY NÁSTRČNÝCH KLÍČOV



S18HEX

Sada nástrčných klíčov s výstupm na skrutky

1/2" Šesthran

- Vysoko výkonná legovaná oceľ, matný povrch
- ISO 1174/DIN 3120

NOVINKA

69,95 €

● M 4 5 6 7 8 10 12 14 17	←mm→ 60
● M 4 5 6 7 8 10 12 14 17	←mm→ 130



24,95 €

S9HEX

Sada nástrčných klíčov s výstupm na skrutky

1/2" Šesthran

- Vysoko výkonná legovaná oceľ, matný povrch
- ISO 1174/DIN 3120

● M 4 5 6 7 8 10 12 14 17



S18TORX

Sada nástrčných klíčov s výstupm na skrutky

1/2" TORX®

- Vysoko výkonná legovaná oceľ, matný povrch
- ISO 1174/DIN 3120

NOVINKA

57,95 €

● T20 T25 T27 T30 T40 T45	←mm→ 60
● T50 T55 T60	
● T20 T25 T27 T30 T40 T45	←mm→ 130
● T50 T55 T60	



22,95 €

S9TORX

Sada nástrčných klíčov s výstupm na skrutky

1/2" TORX®

- Vysoko výkonná legovaná oceľ, matný povrch
- ISO 1174/DIN 3120

● T20 T25 T27 T30 T40 T45 T50 T55 T60

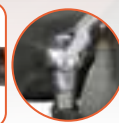

SW79

Sada nástrčných klíčov s račňou s výkyvnou hlavou

1/4" + 1/2"

- Metrické rozmery
- Vysoko výkonná legovaná oceľ, matný povrch
- ISO 1174/DIN 3120

NOVINKA

119,00 €



○ 1/4"	4 4.5 5 5.5 6 7 8 10 11 12 13
● 1/4"	Ráčňa s výkyvnou hlavou
● 1/4"	
● 1/4"	75 & 150 mm
○ 1/2"	10 11 12 13 15 16 17 18 19 21 22 23 24 27
● 1/2"	Ráčňa s výkyvnou hlavou
● 1/2"	125 & 250 mm
○ 3/8"	1/2"
○ 1/4"	1/4"
+	PH1 PH2
+	PZ1 PZ2
+	T10 T15 T20 T25 T27 T30
●	M 3 4 5 6
● 1/4"	1/4" 1/4" 1/4" 1/4"
○	SL 3.0, 4.5, 5.5
+	1xPH1, 4xPH2, 1xPH3, 2xPH2G
+	1xPZ1, 4xPZ2, 1xPZ3
+	1xT10, 2xT15, 2xT20, 1xT25, 1xT27, 2xT30
●	M 3 4 5 6



139,95 €

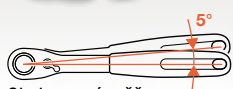

Obojsmerná račňa s úzkou hlavou a 72 zubami

S95

Sada nástrčných kľúčov



1/4" + 1/2"

NOVINKA

- Metrické rozmery
- Vysoko výkonná legovaná oceľ, matný povrch
- ISO 1174/DIN 3120



1/4"	4 4.5 5.5 6 7 8 9 10 11 12 13
1/4"	72 zubov, uhol záberu 5°
1/4"	
1/4"	75 & 150 mm
1/4"	&
1/2"	10 11 12 13 14 15 17 18 19 20 21 22 24 27 30 32
1/2"	16 21
1/2"	72 zubov, uhol záberu 5°
1/2"	125 & 150 mm
1/2"	&
1.5 2 2.5 3 4 5 6 8 10	
7, 8, 9, 10, 11, 12, 13, 14, 15, 16, 17, 18, 19	
1/4"	1/4" 1/4" 1/4"
4.5 5.5	
PH1 PH2 PH2 PH2 PH2 PH3 PH2G PH2G	
PZ1 PZ2 PZ2 PZ2 PZ3	
T10 T15 T15 T15 T20 T20 T20 T25 T25 T27 T30	
M 3 4 5 6	



165,00 €

S106

Sada nástrčných kľúčov



1/4" + 1/2"

- Metrické + Palcové rozmery
- Vysoko výkonná legovaná oceľ, matný povrch
- ISO 1174/DIN 3120



Bahco Online-Katalóg >



1/4"	4 4.5 5.5 6 7 8 9 10 11 12 13
1/4"	4 5 6 7 8 9 10 11 12 13
1/4"	60 zubov, uhol záberu 6°
1/4"	
1/4"	75 & 150 mm
1/4"	&
1/2"	10 11 12 13 14 15 17 19 20 22 24 27 30 32
1/2"	3/8" 7/16" 1/2" 9/16" 11/16" 3/4" 13/16" 7/8" 1/2" 1.3/16"
1/2"	16 21
1/2"	17 19 21 24
1/2"	60 zubov, uhol záberu 6°
1/2"	250 mm
1/2"	125 & 150 mm
1/2"	&
1/4"	1/4"
1/4"	1/4"
4 5.5 7	
PH 1 2 3 4	
M 3 4 5 6 7 8	
1.5 2 2.5	
8 9 10 11 12 13 14 15 17 19 21 24 27	
8-9 10-11 12-13 14-15	



239,00 €

SLX 17

Sada nástrčných kľúčov



3/4"

- Metrické rozmery
- Vysoko výkonná legovaná oceľ, matný povrch
- ISO 1174/DIN 3120

Bahco Online-Katalóg >



22 24 27 30 32 33 34 36 38 41 46 50
3/4"
3/4"
500 - 815 mm
3/4"
200
3/4"
400
3/4"



- Kufor z vysoko odolného polyetylénu HDPE; odolný voči nárazom, olejom a teplotám

SADY RÁZOVÝCH NÁSTRČNÝCH KLÚČOV



D/S10
Sada rázových nástrčných klúčov

10

1/2"

- Vysoko výkonná legovaná oceľ, čierne
- DIN 3129, ISO 2725



DYNAMIC-DRIVE™

43,20 €

○ 10 11 12 13 14 15 16 17 18 19	←mm→ 38
⊕ x2	



D/S14
Sada rázových nástrčných klúčov

14

1/2"

- Vysoko výkonná legovaná oceľ, čierne
- DIN 3129, ISO 2725



DYNAMIC-DRIVE™

47,15 €

○ 10 11 12 13 14 15 16 17 18 19	←mm→ 38
○ 20 21 22	
○ 24 27	←mm→ 45
⊕ x1	



DD/S10
Sada rázových nástrčných klúčov, dlhých

10

1/2"

- Vysoko výkonná legovaná oceľ, čierne
- DIN 3129, ISO 2725



DYNAMIC-DRIVE™

60,30 €

○ 10 11 12 13 14 15 16 17 18 19	←mm→ 80
---------------------------------	---------



DD/S14
Sada rázových nástrčných klúčov, dlhých

14

1/2"

- Vysoko výkonná legovaná oceľ, čierne
- DIN 3129, ISO 2725



DYNAMIC-DRIVE™

97,35 €

○ 10 11 12 13 14 15 16 17 18	←mm→ 80
○ 19 20 21	
○ 22 24 27	←mm→ 88
⊕ x3	



D-DD/S20
Sada rázových nástrčných klúčov

20

1/2"

- Vysoko výkonná legovaná oceľ, čierne
- DIN 3129, ISO 2725



DYNAMIC-DRIVE™

76,20 €

○ 10 11 12 13 14 15 16 17	←mm→ 38
○ 18 19	
○ 10 11 12 13 14 15 16 17	←mm→ 80
○ 18 19	
⊕ x3	

PRIECHODNÁ RAČŇA A NÁ- STRČNÉ KLÚČE



169,00 €

K8901M/8 Sada rázových nástrčných klúčov



3/4"

- Vysoko výkonná legovaná oceľ, čierne
- DIN 3129, ISO 2725



○ 21 22 24 27 30 32 36 41 | <mm> 51-58



S prepínacou páčkou

5°

- Priechodná obojsmerná račňa pre dlhé závit, 3/8" (19 mm)
- 72 zubov, uhol záberu 5°
- S flexibilnou hlavou pre lepší prístup



275,00 €

K8906M/8 Sada rázových nástrč- ných klúčov, dlhých



3/4"

- Vysoko výkonná legovaná oceľ, čierne
- DIN 3129, ISO 2725



○ 21 22 24 27 30 32 36 41 | <mm> 95-100



49,50 €

S140T Sada nástrčných klúčov s priechodnou račňou



- Vysoko výkonná legovaná oceľ, matný povrch
- DIN 3120, ISO 1174

○ □ 10 11 12 13 14 15 16 17 19 21 22 24
○ 3/8" 72 zubov
○ 3/8" 3/8" <mm> 75



- Kufoz z vysoko odolného polyetylénu HDPE; odolný voči nárazom, olejom a teplotám



95,00 €

S530T Sada nástrčných klúčov s priechodnou račňou



- Vysoko výkonná legovaná oceľ, matný povrch
- DIN 3120, ISO 1174

○ □ 10 11 12 13 14 15 16 17 19 21 22 24
○ 8 9 10 11 12 13 14 15 16 17
○ E8 E10 E11 E12 E14 E16 E18 E20 E22
○ 3/8" 72 zubov
○ 3/8" 3/8" <mm> 75
○ 3/8" 1/4" & 3/8" & 1/2"
○ 3/8" 1/4" & 5/16"
○ 5/16" M 7 8 10 12 mm
○ 5/16" TTX 40H 45H 50H 55H
○ 1/4" M 5 6 mm
○ 1/4" TTX 20H 25H 27H 30H

KLÚČE

111- Sada kombinovaných očka/vidlica klúčov

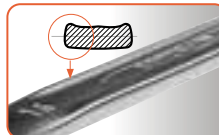

Rukoväť klúča U-profil,
užšia plocha vidlice



Zosilnený profil očka aj
vidlice

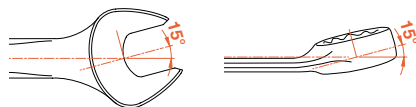

■ ISO 691 / ISO 7738 / ISO 3318 /
ISO 1711-1 / DIN 3113

V plastovom zavinovacom puzdre, metrické



49,95 €

111M/11T

8 9 10 11 12 13 14 15
17 19 22 mm



96,75 €

111M/14T

6 8 9 10 13 14 15 17 19 22
24 27 30 32 mm



195,00 €

111M/26T

6 7 8 9 10 11 12 13 14 15 16 17 18 19
20 21 22 23 24 25 26 27 28 29 30 32 mm



Palcové rozmery



111Z/11T

3/8" 7/16" 1/2" 9/16"
5/8" 11/16" 3/4" 13/16"
7/8" 15/16" 1"



79,50 €

V plastovom držiaku

- so sponou na opasok
- jednoduchá identifikácia



111M/SH12

8 9 10 11 12 13 14
15 16 17 18 19 mm



70,00 €





Úzka hlava pre lepšiu prístupnosť

Široké kontaktné plochy a ľahko čitateľné značenie uľahčujú prácu

Vysoko výkonná legovaná oceľ

Zosilnený profil očka so zmenšeným vonkajším priemerom uľahčuje manipuláciu v stiesnených priestoroch

Pochrómovaná a Micro matná vysokokvalitná povrchová úprava

Asymetrický U-profil rukoväte poskytuje lepšie pohodlie pri uchopení

12-bodový Dynamic-Drive profil zabezpečuje dlhšiu životnosť skrutiek a matíc

6M/10C

Sada obojstranných vidlicových kľúčov



- ISO 691 / ISO 1085 / ISO 10102 / ISO 3318

10



82,85 €

6x7 8x9 10x11 12x13 14x15 16x17 18x19 20x22 24x27 30x32 mm

S20/SH12

Sada kombinovaných očko/vidlica kľúčov, séria S



12



78,25 €

6 7 8 9 10 11 12 13 14 15 17 19 22 mm

1936M/7

Sada obojstranných rúrkových kľúčov

7+2

- DIN 896-B
- Z rúrky, rovné

25,00 €



Obsah:

8x9 10x11 12x13 14x15 16x17 18x19 20x22 mm,
2 stupňovité tyčky 6-10 a 12-16 mm

4106-

Nastaviteľný hákový kľúč



- Kíbová hlava s hákom pre rôzne priemery límcov, krúžkov a ložísk

BAHCO	mm	mm	g	€
4106-19-50	19-50	158	130	16,20
4106-20-35	20-35	165	185	20,30
4106-32-75	32-75	203	240	20,70
4106-35-60	35-60	210	170	22,30
4106-60-90	60-90	280	360	28,35
4106-90-155	90-155	335	610	36,65
4106-155-230	155-230	460	1200	63,25

KOMBINOVANÉ...

1RM- Kombinované račňové kľúče



■ ISO 1711-1 / DIN 3113

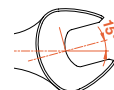
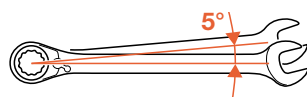

- Vysoko výkonná legovaná oceľ
- Pochromovaná a Micro matná vysokokvalitná povrchová úprava

BAHCO	mm	mm	g	€
1RM-6	6	128	27	8,40
1RM-7	7	140	35	8,40
1RM-8	8	140	38	8,40
1RM-9	9	150	48	8,90
1RM-10	10	159	59	9,45
1RM-11	11	165	67	9,45
1RM-12	12	172	82	9,95
1RM-13	13	178	95	9,95
1RM-14	14	191	113	10,70
1RM-15	15	200	130	12,65

BAHCO	mm	mm	g	€
1RM-16	16	208	158	12,20
1RM-17	17	226	180	13,05
1RM-18	18	237	213	13,35
1RM-19	19	248	233	13,65
1RM-21	21	290	343	24,20
1RM-22	22	290	343	18,50
1RM-24	24	323	503	22,05
1RM-27	27	359	550	36,25
1RM-30	30	393	750	42,55
1RM-32	32	425	900	48,35

Sada kombinovaných račňových kľúčov, metrických

Palcové rozmery

69,95 €

1RM/SH6

8 10 12 13 14 17 mm

98,10 €

1RM/SH8

8 10 11 12 13 14 17 19 mm

145,00 €

1RM/SH12

8 9 10 11 12 13 14 15 16 17 18 19 mm

229,40 €

1RZ/SH8

5/16" 3/8" 7/16" 1/2" 9/16" 5/8" 11/16" 3/4"

10RM/SH6 Sada kombinovaných račňových kľúčov, krátkych

■ ISO 3318 / DIN 3113

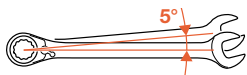

72,95 €



8 10 13 14 17 19 mm



41RM/SH8 Sada kombinovaných račňových kľúčov, s výkyvnou hlavou

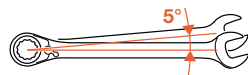
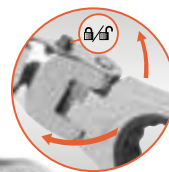

83,95 €



8 10 11 12 13 14 17 19 mm



... RAČŇOVÉ KLÚČE



42RM/S12

Sada račňových očkových klúčov s kĺbom

12

- Nastaviteľný kĺb, ktorý možno otočiť o 360° a 180°



DYNAMIC-DRIVE™

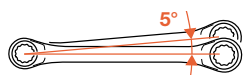

245,00 €

8 9 10 11 12 13 14 15 16 17 18 19 mm
+ 1 rukoväť



1320RM/SH8

Sada obojstranných račňových klúčov

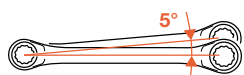

DYNAMIC-DRIVE™

150,00 €

8

6x7 8x9 10x11 12x13 14x15
16x17 18x19 22x24 mm



S4RM/3T

Sada obojstranných račňových klúčov, 4 v 1

3



DYNAMIC-DRIVE™

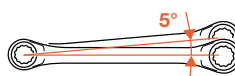

12 ROZMEROV V 3 KLÚČOCH

8x9x10x11mm
12x13x14x15 mm
16x17x18x19 mm

39,00 €



NASTAVITEĽNÉ KLÚČE

9029 C / 9031 C

Nastaviteľné klúče ERGO™



- ISO 6787, DIN 3117, ASME B107.8M-2003 a BS 6333



Pohodlná a protišmyková rukoväť z termoplastického materiálu

- Pochromované, presne kalené s protikoróznou úpravou

BAHCO	mm	mm	mm	g	€
9029 C	32	5	170	220	24,90
9031 C	38	6	218	340	24,05

9029-T / 9031-T

Nastaviteľné klúče ERGO™ so štíhlymi čeľuťami



Pohodlná a protišmyková rukoväť z termoplastického materiálu



- Fosfátované, presne kalené s protikoróznou úpravou

BAHCO	mm	mm	mm	g	€
9029-T	32	4.5	170	196	24,70
9031-T	38	4.5	218	325	30,95

80

Klasické nastaviteľné klúče



- ISO 6787, DIN 3117, ASME B107.8M-2003 a BS 6333

- Pochromované, presne kalené s protikoróznou úpravou
Klúče 8074 a 8075 sú čierne

BAHCO	mm	mm	mm	g	€
8069 C IP	13	4	110	60	18,20
8070 C IP	20	4.9	155	132	22,95
8071 C IP	27	6	205	255	24,25
8072 C IP	30	8.6	255	400	31,50
8073 C IP	34	11.9	305	665	46,20
8074 C IP	44	14	380	1035	59,90
8075 C IP	53	17.7	455	1665	108,00
8074	44	14	380	1035	53,50
8075	53	17.7	455	1665	83,50

ADJUST 3

Sada nastaviteľných klúčov



- Čierne, presne kalené s protikoróznou úpravou

49,00 €



Obsah	mm	mm
8070	20	155
8071	27	205
8072	30	255

86

Nastaviteľný klúč

- ISO 6787, DIN 3117, BS 6333, ASME B107.8M - 1996



177,00 €

mm	mm	g
63	614	3165

- Fosfátované, presne kalené s protikoróznou úpravou



BESKRIFNING

OFFENTLIGGJORD AF

1892

Nastavitelný kľúč bol vynájdený a patentovaný v roku 1892 J. P. Johanssonom, zakladateľom firmy Bahco. Odvtedy spoločnosť Bahco neustále pracuje na zlepšovaní dizajnu a prevedení.

ADJUST 9031/29



Sada nastaviteľných kľúčov ERGO™

■ Čierne

34,00 €



+40%

Obsah	 mm	 mm
9029 C	32	170
9031 C	38	218

BOČNÉ ŠTIEPACIE KLIESTE

2101G

Bočné štiepacie kliešte ERGO™ pre elektrikárov

■ ISO 5749

ergo®



Ergonomická dvojzložková rukoväť pre optimálne uchopenie



Progressívne rezné hrany:
Štiepanie tvrdých materiálov tesne pri k be a mäkkých materiálov pri špi ke



Indukcne kalené rezné hrany

Skrutka poskytuje vynikajúci chod a presné nastavenie rezných hrán

BAHCO	mm	Fe+ mm		€
2101G-125	125	2.2	čierna	19,55
2101G-140	140	2.5	čierna	19,85
2101G-160	160	2.7	čierna	20,35
2101G-180	180	2.7	čierna	21,70

BAHCO	mm	Fe+ mm		€
2101GC-125IP	125	2.2	pochrómované	21,90
2101GC-140IP	140	2.5	pochrómované	22,20
2101GC-160IP	160	2.7	pochrómované	22,70
2101GC-180IP	180	2.7	pochrómované	24,45

21HDG-180

Bočné štiepacie kliešte ERGO™ pre mechanikov

■ ISO 5749

ergo®



Progressívne rezné hrany



25,40 €

Úzky tvar hlavy umožňuje dobrú prístupnosť aj s otvorenými čelistami



mm	Fe+ mm
180	2.7

1520 G

Pákové štiepacie kliešte



63-64 Hrc



42,15 €

Centrické presné hrany na štiepanie strunového, tvrdého a mäkkého drôtu

mm	Fe+ mm
208	3.8



2101PG-160

Bočné štiepacie kliešte ERGO™

■ ISO 5749

špeciálne na plasty



Indukcne kalené rezné hrany

mm	CU	PA (Nylon)
160	1.5 mm	3.0 mm

35,40 €

KLIEŠTE ERGO™

2628 G- Kombinované kliešte ERGO™

■ ISO 5746

ergo®

Ergonomická dvojzložková rukoväť pre optimálne uchopenie



Otváracia pružina dnu/von

Indukčne kalené ezne hrany

Úzky zaoblený tvar



2628 GC-
pochrómované

2628 G
čierna

BAHCO	mm	mm*		€
2628 GC-160IP	160	2.0	pochrómované	24,05
2628 GC-180IP	180	2.5	pochrómované	22,95
2628 GC-200IP	200	3.0	pochrómované	27,60
2628 G-160	160	2.0	čierna	18,05
2628 G-180	180	2.5	čierna	20,20
2628 G-200	200	3.0	čierna	21,90

* Strunový drôt

2430 G- Kliešte so špicatými plochými čelustami ERGO™

■ ISO 5745

ergo®

2430 GC-
pochrómované

Štíhle, polkruhové a vrúbkované čeluste



2430 G
čierna

Dlhé špičky pre lepší prístup v stiesnených priestoroch

BAHCO	mm	CU mm	Fe mm	Fe+ mm	€
2430 GC-160 IP	160	3.0*	1.8*	1.6*	25,15
2430 GC-200 IP	180	3.0*	1.8*	1.6*	33,50
2430 G-160	160	3.0*	1.8*	1.6*	20,55
2430 G-200	180	3.0*	1.8*	1.6*	25,15

2427 G- Kliešte so špicatými čelustami ERGO™, so zahnutou špičkou

■ ISO 5745

ergo®

2427 GC-
pochrómované

45°



2427 G
čierna

Štíhle, polkruhové a vrúbkované čeluste

BAHCO	mm	CU mm	Fe mm	Fe+ mm	€
2427 GC-160IP	160	3.0	1.8	1.6	28,15
2427 GC-200IP	160	3.0	1.8	1.6	33,75
2427 G-200	200	3.0	1.8	1.6	23,30

72- Kliešte s posuvným kĺbom

■ ISO 8976

Pohodlná dvojzložková rukoväť



Štíhle čeluste pre lepší prístup v stiesnených priestoroch

25 nastaviteľných polôh



BAHCO	mm	mm	€
7223	49	200	22,65
7224	61	250	24,60
7225	71	300	33,20

82- Kliešte s posuvným kĺbom ERGO™

ergo®

■ ISO 8976

Tlačidlo na nastavenie rozovretia jednou rukou



Pohodlná dvojzložková rukoväť

11 – 12 nastaviteľných polôh

BAHCO	mm	mm	€
8224CIP	45	250	33,35
8225CIP	55	315	44,30

1410/1420 Rúrkové kľúče ERGO™

ergo®

■ DIN 5234

■ Štíhle čeluste pre lepší prístup v stiesnených priestoroch

Pohodlná dvojzložková rukoväť



Patentované progresívne ozubenie s indukčne kalenými čelustami pre lepšie uchopenie rúrok

BAHCO	mm	mm	mm	€
1410	45	1" – 38 mm	320	37,65
1420	65	1½" – 57 mm	430	48,10

ŠPECIÁLNE KLIESTE

9938

Sada klieští na poistné krúžky

- Pre vnútorné poistné krúžky Ø 8 – 100 mm a vonkajšie poistné krúžky Ø 3 – 100 mm

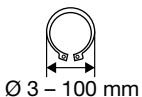
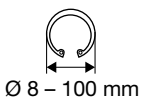

109,00 €

Svojim rozsahom pokryje viac ako 10 bežných veľkostí bežných klieští na poistné krúžky

2928-160



2928-200



2928-250



- Vymeniteľné špičky (rovné, zahnuté 15° a 90°) pre vnútorné alebo vonkajšie poistné krúžky

Obsah	mm	mm	mm	
2928-160	160	7-26	3-35	5
2928-200	200	10-51	7-51	5
2928-250	250	46-102	32-102	6

9897

Sada klieští ERGO™

ergo®



Obsah	
2101G-160	Bočné štiepacie kliešte
2628G-180	Kombinované kliešte
2430G-160	Kliešte so špicatými čeľuštami
8224	Kliešte s posuvným kĺbom

83,40 €

28-29/S4

Sada klieští na poistné krúžky

- Pre vnútorné poistné krúžky a vonkajšie poistné krúžky

71,70 €



2800-180
s rovnou špičkou

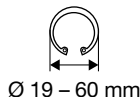

2890-180
so zahnutou špičkou



2900-180
s rovnou špičkou

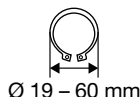

2990-180
so zahnutou špičkou



■ Nožnice na plastové rúrky

Račňový mechanizmus



PE, PP, PB, PEX, MLP/MSR, VPE, CPVC, PVC, PVDF

- Jednoduché ovládanie, čisté a presné rezy
- Na výmenu čepele nie je potrebné náradie
- Rýchle uvoľnenie čepele jednou rukou

Čepeľ z nehrdzavejúcej ocele s povlakom PTFE



411-35



411-42

Pohodlná 2-zložková rukoväť

BAHCO	mm	mm	g	€
411-35	35	220	273	38,70
411-42	42	240	435	50,75

2650 Konektorové kliešte



1 | 2 | 3
Nastaviteľné do 3 polôh

33,50 €

- S vymeniteľnými nylonovým vložkami a posuvným kĺbom
- Zabraňujem poškodeniu povrchov

mm	mm
235	65

2855 Kliešte na skrúcanie drôtov



104,95 €

Zahnuté vrúbkované čeluste, so strihačom drôtov

- Pre bezpečné a spoľahlivé upevňovanie častí, vystavených vibráciám, pomocou skrúcaného drôtu
- Umožňujú veľmi rýchle a časovo úsporné rovnomerné skrúcanie drôtov

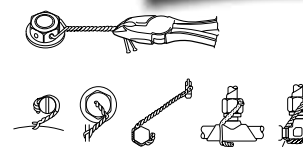

mm	Fe+ mm
235	1.04

Nožnice na plech

- Kované čepele zo špeciálne kalenej nástrojovej ocele

Rukoväte zo sklolaminátu a nylonu

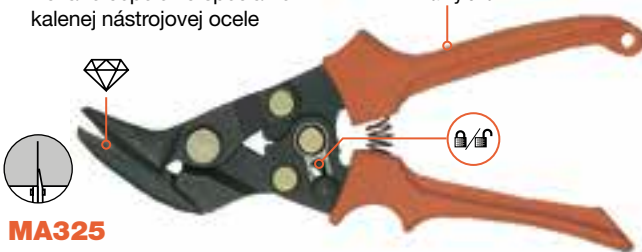

MA325

- Prevodové vystrihovacie nožnice
- Na rovný strih a vystrihovanie z plechov



Mäkké rukoväte s vratnou pružinou



MA351 / MA361

- Na rezanie ocelevej zliatiny s obsahom chrómu a molybdénu
- Vyhnutá strihacia hlava pre lepší prístup

BAHCO	mm	Strih	1 mm	2 mm	€
MA325	250	rovný	0.8	1.2	34,75
MA351	250	do ľava	1.0	1.5	24,34
MA361	260	do prava	1.0	1.5	24,45

Max. strihacia kapacita 1 = nehrdzavejúca oceľ, 2 = oceľ valcovaná za studena

316-2 Výstružník v tvare pera

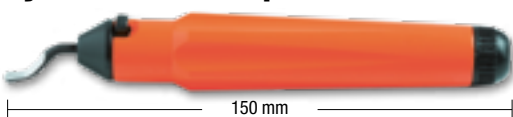

150 mm

- Plastový kryt s extra HSS čepeľou vo vnútri
- Náhradná čepeľ je dostupná: 316-2-95

14,91 €

2951-250 Pridržiavacie kliešte s prestrihovačom drôtov



Zakrivené tenké čeluste



Prestrihovač na štiepanie olovej pájky a pod.

mm	mm	Fe+ mm
250	63	3.0

24,95 €

PNEUMATICKÉ NÁRADIE

Rázové uťahovačky

120 mm



BPC813

1/2"

max. 678 Nm



BPC814

1/2"

max. 624 Nm



BPC815

1/2"

max. 1112 Nm



BPC817

3/4"

max. 2034 Nm

BAHCO	BAR	mm	l/min	Nm	Max Nm	min ⁻¹	dbA	mm	kg	€
BPC813	6.3	10	113	407	678	10000	87	120	1.54	155,95
BPC814	6.3	10	113	338	624	12000	87	142	1.24	175,00
BPC815	6.3	10	113	786	1112	8000	88	187	1.91	219,00
BPC817	6.2	10	198	1627	2034	5000	96	220	3.44	440,00

Video návody na použitie & údržbu



BP500
Magnetický držiak pre rázové uťahovačky

45,00 €

BP814A

Rázový račňový uťahovák

302,00 €

1/2"

max. 244 Nm

- Výkonnejšia a rýchlejšia ako rača
- Lepší prístup než pri použití rázového kľúča
- Ideálna pre prácu v zúžených miestach

BAR	mm	Nm	Max Nm	min ⁻¹	dbA	mm	kg
6.2	10	195	244	7000	97	334	1.8

BP601

Excentrická brúska 5 mm

145,00 €

- Vrátane brúsneho kotúča Velcro®



m/sec² < 2.5



Dá sa použiť so systémami s centrálnym odsávaním

mm	BAR	mm	l/min	W	min ⁻¹	dbA	m/sec ²	mm	kg
152	6.3	10	255	224	11000	80	< 2.50	195	0.8

BP700
Mini račna

1/4"



BP820
Račna

3/8"



BP821
Račna

1/2"



BP218
Pneumatická fúkacia pištoľ

- Splňa požiadavky OSHA
- Vložka z mosadze

9,40 €



BAR	mm	l/min	dba	mm	kg
6.3	10	158	<80	210	0.15

BP219
Pneumatická fúkacia pištoľ

- Vložka z mosadze

9,45 €



BAR	mm	l/min	dba	mm	kg
6.3	10	68	<80	240	0.13

BP822
Priama brúska 3 mm

Pogumovaná rukoväť

95,00 €



mm	BAR	mm	l/min	W	min ⁻¹	dba	m/sec ²	mm	kg
3	6.3	10	170	201	25000	85	4.52	165	0.5

Špirálové vzduchové hadice

- Pružné polyuretánové hadice s pevnými prípojkami s vonkajším závitom na oboch koncoch



BAHCO	BAR		mm	m	kg	€
BPH1010B	6.3	1/4-1/4 BSP	10	10	0.86	28,30
BPH1310A	6.3	3/8-3/8 NPT	13	10	1.67	56,75

Bubny na vzduchové hadice



- Otočné 145° zavesenie
- Polypropylénový kryt odolný voči korózii
- Západkový systém automaticky blokuje rozvinutú hadicu na potrebnej dĺžke



Otváracia/zatváracia pružina pre západkový systém

BAHCO	BAR		mm	m	kg	€
BPHRC815	15	1/4-1/4	8	15	5.5	228,00
BPHRC1015	15	3/8-3/8	10	14+1	5.9	249,00

PÍLOVÉ PÁSY

**Presnosť nepozná
žiadne kompromisy.**

**Naše štandardy
kvality tiež nie.**

BI-METALOVÉ PÍLOVÉ PÁSY

Špičky zubov vyrobené z vysoko účinnej rýchloreznej ocele v kombinácii s pružným nosným materiálom vedú k tomu, že pílové pásy sú vysoko produktívne pre väčšinu aplikácií. Vieme kompletne uspokojiť požiadavky trhu pre viacúčelové, obrysové, rúrkové, profilové rezanie v zlievarňach či výrobných podnikoch. Pílové pásy Sandflex® režu rôzne druhy ocele, napr. konštrukčné ocele, temperované ocele, vysokolegované ocele, nehrdzavejúce ocele, titán, zliatiny na báze niklu, liatiny, mosadze, medi a hliníka a iné materiály.

KARBIDOVÉ PÍLOVÉ PÁSY

Prémiové vysokovýkonné pílové pásy zo spekaného karbidu režu rýchlejšie a majú dlhšiu životnosť ako mnoho iných pílových pásov. Sú vhodné pre rôzne aplikácie. Karbidové pílové pásy sú špeciálne navrhnuté pre vysokoefektívne rezanie ťažko obrábiteľných a abarazívnych materiálov, ako aj pre vysokovýkonné rezanie veľkých a ťažko spracovateľných obrobkov.

Pre viac informácií o pílových pásoch nás prosím kontaktujte.



Video -
Pílové pásy
Easy-Cut v praxi



Video - Výrobný proces
Karbidových pílových
pásov



Stiahnite si PDF
Katalóg pílových pásov



PILNÍKY

1-478- Sada pilníkov ERGO™

■ V zavinovacom puzdre



ergo®

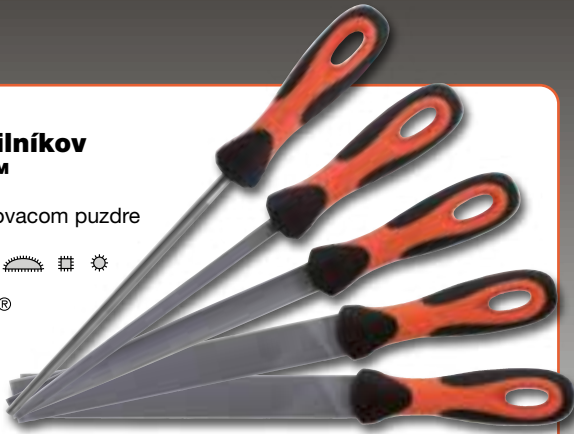

- Koniec rukoväte úplne zakrýva stopku pilníka pre bezpečné a pohodlné držanie
- Obsahuje po 1 kuse: Plochý pilník (sek 2*), plochý, štvorhranný, polkruhový a kruhový pilník (Sek 1*)

BAHCO	Obsahuje	€
1-478-08-1-2 200 mm	1-210-08-1-2; 1-230-08-1-2; 1-100-08-1-2; 1-100-08-2-2; 1-160-08-1-2	27,65
1-478-10-1-2 250 mm	1-210-10-1-2; 1-230-10-1-2; 1-100-10-1-2; 1-100-10-2-2; 1-160-10-1-2	30,70

* Sek 1 = Polohrubý, Sek 2 = Stredný



Sady ihlových pilníkov

■ Na jemné pilovanie a leštiace práce



2-470-16-2-0



2-472-16-2-0



- Sek: 2 = Stredný
- Obsahuje po 1 kuse: plochý, plochý špicatý, polkruhový, kruhový, trojhranný a štvorhranný pilník a plastovú rukoväť

- Sek: 2 = Stredný
- Obsahuje po 1 kuse: plochý, plochý špicatý, trojhranný, štvorhranný, polkruhový, jazýčkovitý, kruhový, nožovitý, nízky tupouhý trojhranný, mečovitý, značkovací pilník a pilník so zaoblenými hranami a plastovú rukoväť

1-100- Plochý pilník ERGO™

ergo®



BAHCO	mm	Sek*	€
1-100-08-1-2	150	1	7,05
1-100-08-2-2	150	2	7,25
1-100-10-1-2	200	1	8,40
1-100-10-2-2	200	2	8,60

1-210- Polkruhový pilník ERGO™

ergo®



BAHCO	mm	Sek*	€
1-210-08-1-2	150	1	9,35
1-210-08-2-2	150	2	9,45
1-210-10-1-2	200	1	10,85
1-210-10-2-2	200	2	11,15

* Sek 1 = Polohrubý, Sek 2 = Stredný

1-170- Trojhranný pilník ERGO™

ergo®



BAHCO	mm	Sek*	€
1-170-08-1-2	150	1	7,90
1-170-08-2-2	150	2	6,80
1-170-10-1-2	200	1	9,50
1-170-10-2-2	200	2	9,70

1-230- Kruhový pilník ERGO™

ergo®



BAHCO	mm	Sek*	€
1-230-08-1-2	150	1	6,95
1-230-08-2-2	200	1	7,10
1-230-10-1-2	150	2	7,75
1-230-10-2-2	200	2	7,95

DIEROVACIE PÍLY

3834-SET-72-35/83

Sada dierovacích píl

- Bimetal s kalenými zubami z vysokolegovanej rýchloreznej ocele
- Pre všetky opracovateľné materiály ako drevo, oceľ, kov, vrátane nerezovej ocele



	Ø mm	35 40 44 51 57 68 83
--	------	----------------------

Upínacie stopky	Ø 32-100 mm	
-----------------	-------------	--

Vystreďovací vrták	Ø 6,35
--------------------	--------



4/6 max. 38 mm

59,00 €

NOVINKA



119,00 €

NOVINKA

4/6 max. 38 mm

3834-SET-152

Sada dierovacích píl pre mechanikov, inštalatérov a elektrikárov

- Bimetal s kalenými zubami z vysokolegovanej rýchloreznej ocele
- Pre všetky opracovateľné materiály ako drevo, oceľ, kov, vrátane nerezovej ocele



	Ø mm	16 19 22 25 32 35 44 51 57 60 65 68 73 76 83
--	------	-------------------------------------------------

Upínacie stopky	Ø 14-30 mm & Ø 32-210 mm	
-----------------	--------------------------	--

Vystreďovací vrták	Ø 6,35
--------------------	--------

3834-upsize

Adaptér na vystreďovací vrták dierovacej píly

- Na zväčšenie existujúcich otvorov
- Umožňuje upevniť menšiu dierovaciu pílu ako vodiacu pri vrtaní väčšieho priemeru

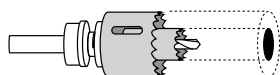
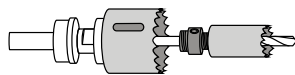

≥ 32 mm < 32 mm

2,00 €



Praktické video



<https://youtu.be/F9wCwN0Wfvg>

PÍLY NA KOV

319

Ručná rámová píla na kov



■ Lhký rám s oceľovým jadrom

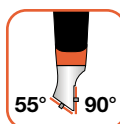

Upínací
mechanizmus
v rukoväti

Sandflex® Bimetal
◀mm▶ | T/”
300 | 24

19,00 €



208

Mini rámová píla na kov
250 mm

10,75 €



321

Vykružovacia píla na kov

■ Pílový list
možno
nastaviť do
8 rôznych
polôh

23,80 €

◀mm▶ | T/”
310 | 24

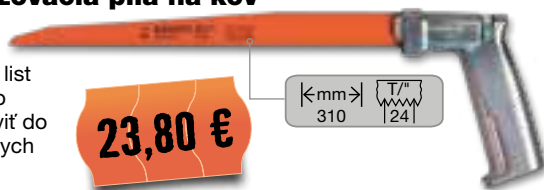

320

Ručná rámová píla na kov

8,95 €

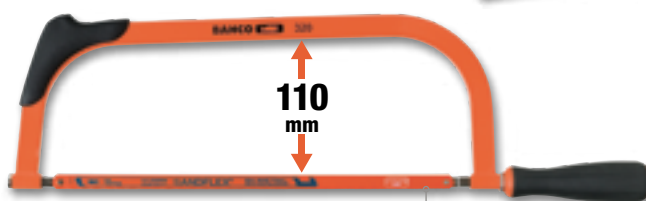

■ Výška rámu 110 mm

■ Možnosť upnutia listu pod 90° uhlom

Sandflex® Bimetal
◀mm▶ | T/”
300 | 24

268

Rámová píla
Junior

8,85 €

■ Sklolaminátová zosilnená rukoväť

◀mm▶ | T/”
150 | 32

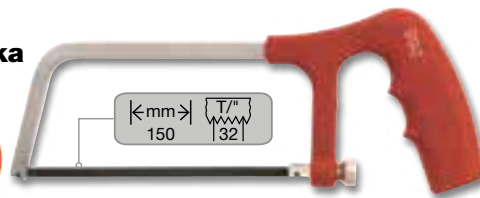

Pílové listy do rámových píl Junior 268

10

■ Na kovy a
drevo



BAHCO	◀▶	T/”	◀mm▶	€
228-32-10P	10	32	150	3,50

3906

Pílové listy SANDFLEX® Bimetal

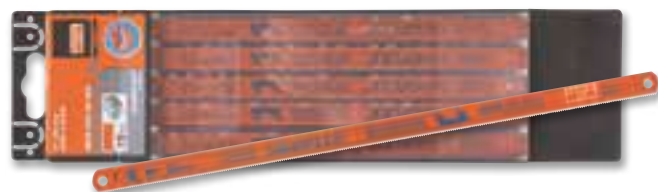

■ Nezlomiteľný, pružný bimetalový pílový list

■ 20% rýchlejší rezný výkon, 35% delší životnosť

BAHCO	◀▶	T/”	◀mm▶	€
3906-300-18-10P	10	18	300 x 13 x 0,65	9,50
3906-300-24-10P	10	24	300 x 13 x 0,65	9,50
3906-300-32-10P	10	32	300 x 13 x 0,65	9,50
3906-300-3P	3	18 / 24 / 32	300 x 13 x 0,65	6,10
3906-300-18-100	100	18	300 x 13 x 0,65	1,20
3906-300-24-100	100	24	300 x 13 x 0,65	1,20

* Cena za kus

KUFRE NA NÁRADIE

Pevné odolné kufre

- Veko zabezpečené 2 kovovými zámkami
- Priehradka na dokumenty



Centrálny zamykací systém s jedným kľúčom



Spodná plocha s odnímateľnými priečkami

Pogumovaná, mäkká rukoväť



Séria 4750RC



Robustná teleskopická rukoväť z hliníka



Séria 4750RCW



Ø 60 x 20 mm



450 x 410 x 210 mm



4750RC02
Pevný odolný kufr

- Panel na náradie vo veku s plastovými vreckami na oboch stranách
- Spodný panel na náradie s plastovými vreckami na jednej strane

186,00 €



465 x 410 x 255 mm



4750RCW01
Pevný odolný kufr s kolieskami

- Panel na náradie vo veku s plastovými vreckami na oboch stranách
- Spodný panel na náradie s plastovými vreckami na jednej strane
- S teleskopickou rukoväťou a kolieskami

319,00 €



465 x 405 x 255 mm



4750RCW011
Pevný odolný kufr s kolieskami

- Panel na náradie vo veku s upínacím gumovým popruhom na oboch stranách
- Spodný panel na náradie s upínacím gumovým popruhom na jednej strane
- S teleskopickou rukoväťou a kolieskami

275,00 €

4750PTB60

Prenosný plastový box na náradie, prázdny

- Mimoriadne odolný a vhodný na použitie v extrémnych podmienkach

35,00 €

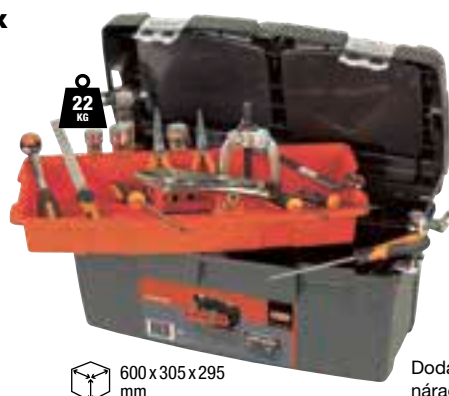

600 x 305 x 295 mm

Dodávka bez náradia

Dlhá hliníková rukoväť

Dva z vonku vyberateľné boxy



Stabilné pevné odlné kufre na náradie z polypropylénu

- Odolné voči korózii, nečistotám, vode a skydrolu
- Kolíky z nehrdzavejúcej ocele
- Uzamykanie pomocou visiacych zámok



4750RCHD01 Pevný odolný kufr

- S polstrovaným ramenným popruhom



545 x 350 x 240 mm

4750RCHDW01 Pevný odolný kufr s kolieskami

- S kolieskami a teleskopickou rukoväťou
- Kolieska: Ø 60 x 20 mm

630 x 480 x 290 mm

4750RCHDW02 Veľký pevný odolný kufr s kolieskami

- S kolieskami a teleskopickou rukoväťou
- Kolieska: Ø 60 x 37 mm

4750RCHDW01FF3

Pevný odolný kufr na kolieskach s teleskopickou rukoväťou vrátane 5 penových modulov s náradím

1/4" + 3/8"

- Vhodné pre všetky typy lietadiel
- Metrické rozmery
- Obsahuje: FF2B12, FF2B13, FF2B14, FF2B15, FF2B16



194

1.699,00 €

Stiahnite si PDF Produktový list

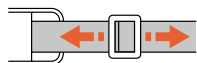

TAŠKY NA NÁRADIE

4750FB1-19B
**19" Zatvárateľná
brašňa na náradie
s krytom, prázdna**

49,50 €

Dodávka bez náradia

- S vystuženým plastovým dnom
- Polstrovaný ramenný popruh a rukoväť

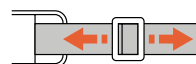
470 x 230 x 355 mm

4750FB1-19A
**19" Otvorená brašňa na náradie
s plastovým dnom, prázdna**

39,50 €

 Dodávka
bez náradia

- Vodotesné plastové dno

470 x 230 x 355 mm

4750-VDEC
**Kožený kufor pre
elektrikárov, prázdny**
155,00 €

- Hliníkový zosilnený rám
- Vnútorňý hliníkový priečinok

290 x 190 x 445 mm

3100TB
**Otvorená brašňa na
náradie, prázdna**

- Vodotesné dno
- Pohodlný polstrovaný ramenný popruh a rukoväť

34,95 €

400 x 600 x 400 mm

4750FB3-12

12" Taška na náradie pre elektrikárov, prázdna



Dodávka bez náradia

Skrytá plastová schránka v spodnej časti

50,00 €

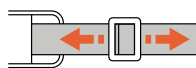

- S vystuženým plastovým dnom

285 x 285 x 190 mm

4750FB4-18

18" Taška pre laptop aj náradie, prázdna

- Polstrovaná priehradka pre laptop
- S vystuženým plastovým dnom

75,00 €



Dodávka bez náradia



350 x 430 x 150 mm

4750-VMPH-1

Puzdro na mobilný telefón

- Na suchý zisk, hodí sa na akýkoľvek opasok

12,10 €



Organizér na náradie, prázdny

Dodávka bez náradia



7,25 €

Dodávka bez náradia

12,75 €

Dodávka bez náradia

15,55 €

4750FB5A Malý

4750FB5B Stredný

4750FB5C Veľký

- Mäkká pogumovaná rukoväť

- Mäkká pogumovaná rukoväť
- Sieťované vrecko na dokumenty

275 x 170 x 55 mm

330 x 270 x 70 mm

400 x 300 x 90 mm

AUTOMOTIVE

BBCE12-10

Plne automatický proces nabíjania riadený mikropocessorom a udržiavacie nabíjanie, **10 ampérov**, 8 fází

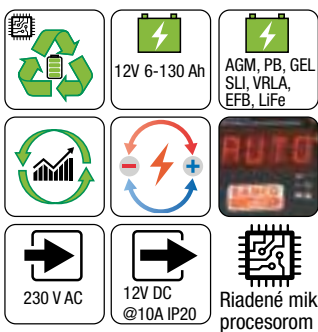

79,95 €



BH13000

Mobilný zdvihák, 3 t

■ Dvojitý piest umožňuje dosiahnuť maximálnu výšku pomocou 6 zošliapnutí



245,00 €



Video návody na použitie & údržbu



CONNECT & FORGET

8-fázový nabíjací cyklus nielen zvyšuje efektívnosť nabíjacieho procesu, ale zaručuje aj správny nabíjací proces, čím sa zabezpečí dlhšia životnosť batérie.

1. Analýza batérie	5. Absorpcia
2. Obnovenie batérie	6. Monitorovanie
3. Mäkký štart	7. Režim konečného dobíjania
4. Režim hlavného nabíjania	8. Udržiavanie

BH4S-

Hydraulické flaškové zdviháky



-20°C – +70°C



BAHCO	T	mm	mm	kg	€
BH4S2	2	181	345	2,2	16,50
BH4S4	4	194	372	3,4	19,90
BH4S6	6	216	413	5,0	23,80
BH4S8	8	230	457	5,7	38,20
BH4S12	12	230	465	7,8	39,75
BH4S20	20	242	452	13,0	63,65

BH5SP500QA

Hydraulický zdvihák prevodoviek

- Používa sa pod zdvihnutými vozidlami na bezpečné odstraňovanie, montáž alebo transport prevodoviek
- Rýchle dosiahnutie úplnej výšky po 38 zdvihoch vďaka dvojrýchlostnej pumpe
- Vysoká stabilita vďaka širokej báze
- Odpružený znižovací mechanizmus

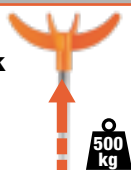

Sedlo možno umiestniť zhora nadol

204,00 €

BH5DP1000QA

Hydraulický zdvihák prevodoviek

- Používa sa pod zdvihnutými vozidlami na bezpečné odstraňovanie, montáž alebo transport prevodoviek
- Rýchle dosiahnutie úplnej výšky po 36 zdvihoch vďaka dvojrýchlostnej pumpe
- Zdvíhanie bremena pomocou nožného pedálu, čím sa uvoľní ruky



Ø 75 mm

499,00 €

SVIETIDLÁ/INŠPEKČNÉ NÁRADIE

5050 Stetoskop

- S oceľovou sondou



50,25 €

5515M Údržbárske zrkadielko

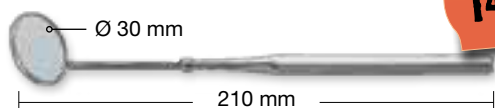

14,90 €

5515T-52 Teleskopické zrkadielko s otočným kĺbom

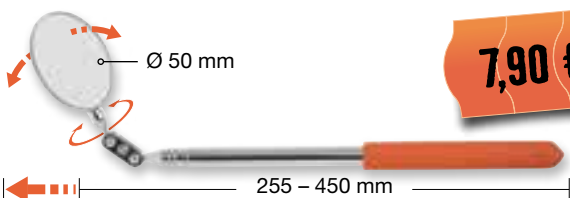

7,90 €

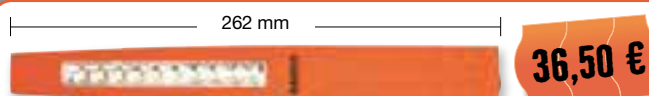

36,50 €

BLTS10 Tenká vrecková baterka



- 10 SMD LED
- 180 Lumen
- 4 h
- IP20
- USB
- 2100 mAh-s Li-ion



BLTS7P Ceruzková vrecková baterka



- 7 SMD LED
- 45 Lumen
- 4 h
- IP20
- USB

BFRL11 Čelovka

- 2 režimy osvetlenia: stretávacie (20 %), diaľkové (100 %)
- Optická šošovka

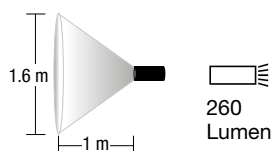

46,05 €

BLTFS6U Flexibilné svietidlo s UV svetlom

- UV svetlo na detekciu netesnosti; kontrolné svetlo a baterka v jednom
- Indikátor nabíjania



64,70 €

- 3 h
- IP20
- 1200 mAh-s Li-ion
- 4 SMD LED
- 250 Lumen
- 80 Lumen
- 6 UV LED



BLTFC1 Flexibilné svietidlo s hliníkovým rámom

- Indikátor nabíjania

55,90 €

- 1 SMD LED
- 180 Lumen
- 2.5 h
- IP20
- 2000 mAh-s Li-ion



BLTS6I Indukčné svietidlo

- Silné a trvanlivé, odolné voči nárazu
- Otočný háčik
- Indikátor nabíjania

Indukčná nabíjacia základňa vybavená otvorom na zavesenie na stenu

115,00 €

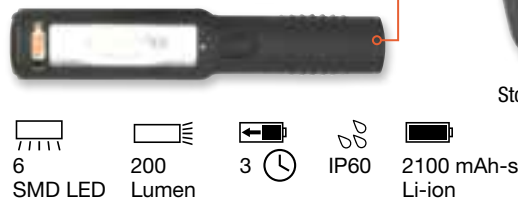

- 6 SMD LED
- 200 Lumen
- 3 h
- IP60
- 2100 mAh-s Li-ion

POZNÁMKY



BAHCO®



SNA Europe [Slovakia] s.r.o.
Karadžičova 8/A, 821 08 Bratislava
Tel.: +421 2 5939 6124
Fax: +421 2 5939 6217
e-mail: info.sk@snaeurope.com
www.bahco.com/sk-sk/

www.bahco.com

SNA Europe
SK akur 2000/19