

BAHCO®

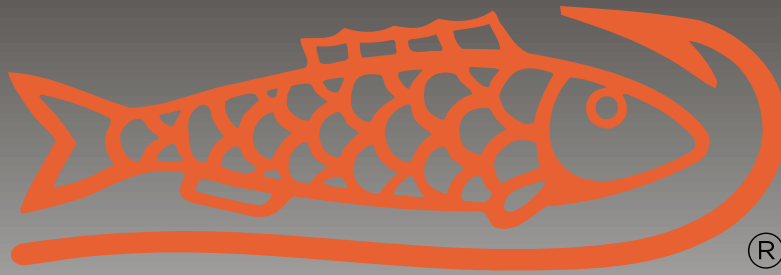

Profesionálom dávame to, čo potrebujú

AUTOMOTIVE HIGHLIGHTS 2021 / 2022



BAHCO

SNA Europe, dcérska spoločnosť spoločnosti Snap-on Inc., je popredným výrobcom ručného náradia a náradia na spracovanie kovov. Výrobky sa predávajú na celom svete prostredníctvom obchodných partnerov pod značkami Bahco, Lindström a Irimo.

Od výroby prvého ručného náradia vo Švédsku v roku 1850 sme vyvíjali a vyrábali náradie pre profesionálov v našich vlastných európskych výrobných závodoch. Naše náradie sa vyznačuje vysokou kvalitou a ergonomickým dizajnom, čo zvyšuje produktivitu, pohodlie a bezpečnosť na pracovisku.

Dnes ponúkame viac ako 15 000 výrobkov, široký sortiment pre používateľov v oblastiach priemyslu, letectva, automobilov, remesiel, záhradníctva a terénnych úprav, ako aj pestovania ovocia a vína.

Profesionálom dávame to, čo potrebujú.

Všetky informácie a ilustrácie uvedené v tejto brožúre sú orientačné a nezáväznú. Zmeny sú vyhradené. Všetky uvedené ceny sú odporúčané maloobchodné ceny bez DPH. Platné do 31.03.2022 alebo do vypredania zásob.



Bahco Partner v motoristickom športe	4-5	
Dielenské vozíky	6-15	
Vybavenie autoservisu	16-17	
Hydraulické a zdvíhacie náradie	18-23	
Dielenské lisy a žeriavy	24-25	
Ručné náradie	26-35	
Pneumatické náradie	36-39	
Akumulátorové náradie	40-43	
Momentové náradie	44-47	
Špeciálne náradie na kolesá a prevodovky	48-53	
Špeciálne náradie na závesné systémy kolies	54-55	
Špeciálne náradie na brzdy	56-57	
Špeciálne náradie na motory	58-60	
Náradie na výmenu oleja	61-63	
Auto-Elektro	64-69	
Karosérie	70-71	
Kontrola / Svetidlá	72-73	

LIFE IS A RACE!

Gosia Rdest. Mladá automobilová pretekárka z Poľska v riadi v tejto sezóne závodný monopost Bahco Alpine A110.

Gosia začínala ako tínedžerka pretekaním na motokárach a dnes jazdí na pretekárskych okruhoch po celom svete.

Od roku 2020 Gosia jazdí za Alpine Team, kde najmä druhú polovicu jej prvej sezóny v pretekoch Alpine Elf Europa Cup možno považovať za úspešnú:

Svoje schopnosti predviedla v 5 pretekoch a vždy skončila na 6. mieste.

Cieľom Gosi v novej sezóne je priniesť trofej do rodného Poľska, najlepšie tú najväčšiu za celkové víťazstvo v pohári.

Pilotka – Gosia Rdest

Dátum narodenia: 14. januára 1993
 Bydlisko: Żyrardów (PL)
 Výška / Váha: 1,63 m / 55 kg
 Webová stránka: www.gosiardest.pl
 Facebook.com: [/GosiaRdestOfficial](https://www.facebook.com/GosiaRdestOfficial)
 Instagram.com: [/gosia.rdest/](https://www.instagram.com/gosia.rdest/)



facebook.com/
GosiaRdestOfficial

BAHCO V MOTOŠPORTE –



ZÁVODENIE JE VÁŠEŇ!

Tak ako v minulých rokoch, aj v tejto sezóne Bahco podporuje preteky Alpine Elf Europa Cup. V tejto sezóne však Bahco po prvý krát sponzoruje svoje vlastné závodné vozidlo: Bahco Alpine A110.



Bahco Heroes
youtu.be/-1rYulgVybs



Follow Bahco Hero Gosia Rdest

PHILIPP LEISEN

VÍTAZ VLN



Pilot – Philipp Leisen

Dátum narodenia: 31. mája 1984 v Trieri
Bydlisko: Irrel / Rheinland-Pfalz (GER)
Výška / Váha: 1,78 m / 75 kg
Webová stránka: www.philipp-leisen.de/
Facebook.com: /PhilippLeisenMotorsport

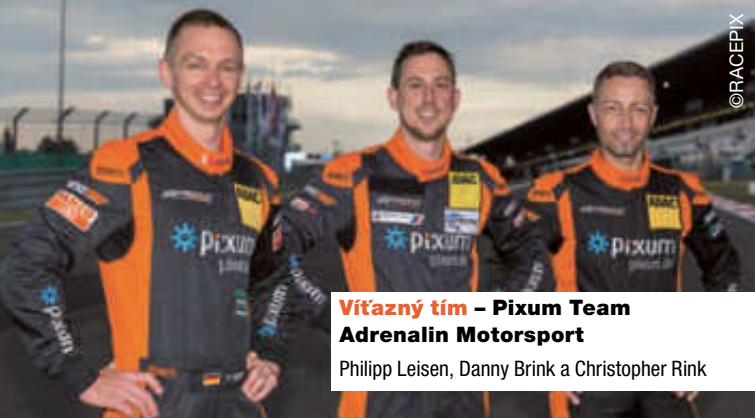

Vítazný tím – Pixum Team Adrenalin Motorsport

Philipp Leisen, Danny Brink a Christopher Rink

Pre rok 2021 sa úradujúci šampión vytrvalostných pretekov VLN snaží získať opäť prvenstvo – išlo by o tretie prvenstvo, ktoré na Nürburgringu zatiaľ dosiahol len veľmi málo závodníkov.

V tejto sezóne počet uchádzačov o titul opäť narástol, takže možno očakávať vzrušujúci boj o titul.

- VLN/NLS - Víťaz 2018 + 2020
- VLN/NLS - Víťaz v sériových automobiloch 2010, 2018, 2020
- Víťaz BMW Sports Trophy 2018
- 3. miesto ADAC VW Polo-Cup 2005
- 35 víťazstiev v triede VLN/NLS
- 3 víťazstvá v SEAT Leon Supercopa
- 3 víťazstvá v triede vytrvalostného preteku ADAC na Nürburgringu



facebook.com/
PhilippLeisenMotorsport

OFICIÁLNY PARTNER ÚSPEŠNÝCH



PRETEKÁRSKE LEGENY

Už od roku 2018 dovážajú Alain Chatton, Peter a Hanspeter Sägerserovci z USA do Švajčiarska pretekárske autá, ktoré majú siluetu áut 30-tych rokov 20. storočia. Tieto špeciály sú vybavené ochranným bezpečnostným rámom odolným aj pri prevrátení auta na strechu.

S hmotnosťou iba 570 kg (vrátane vodiča) má výkon motora 135 konských síl a pôsobivý jazdný výkon. Pri tomto výkone dosahuje max. rýchlosti okolo 210km/h pri zrýchlení z 0 na 100km/h za 3,7s.

S týmito špeciálmi bojuje celkom 30 pretekárov v 3 kategóriách o pohár Swiss Legends Racing.



WANT TO BE A LEGEND



swisslegendsracing.ch



DIELENSKÉ VOZÍKY

Prémiový dielenský vozík s komplexným sortimentom náradia na údržbu vozidiel

AUTO

Dielenský vozík s 9 zásuvkami vybavený 357 kusmi náradia na údržbu vozidiel



Veľmi vysoká nosnosť



Plastová pracovná plocha s priehradkami na malé súčiastky



Ochrana hrán na každej zásuvke



Plne vysúvateľné zásuvky

NOVINKA

- 8 modulov náradia 543 x 445 mm
- Centrálny zámok a zabezpečenie jednotlivých zásuviek

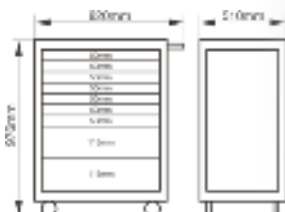

FF1A219LM

Pilník, bity, dlhé a krátke nástrčné kľúče a hlavice 1/2"



FF1A221LM

Skrutkovač, kľúče a nitovacie kliešte



FF1A224LM

Úderové náradie a nôž



FF1A220LM

Kľúče a nastaviteľný kľúč



FF1A222LM

Skrutkovače a bity



FF1A225LM

Rôzne náradie



FF1A223LM

Kliešte



FF1A218LM

Momentový kľúč, nástrčné kľúče a príslušenstvo 1/2" a meracie náradie



2.635,00 €



Stiahnite si PDF Produktový list



Kompletná mobilná dielňa so 758 kusmi náradia v 11 XXL zásuvkách!



MONSTER

Dielský vozík s 8 zásuvkami a nadstavbou so 4 zásuvkami vybavený 758 kusmi náradia



NOVINKA

- 11 modulov náradia 880 x 445 mm
- Centrálny zámok a zabezpečenie jednotlivých zásuviek
- Plná mobilita a tichý chod vďaka dvom pevným a dvom otočným kolieskam z pevnej gumy



Bezpečné spojenie dielského vozíka s nadstavbou

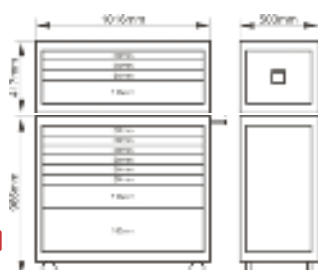

Dvojstenný vystužený rám chráni zásuvky v prípade kolízie

Plne vysúvateľné zásuvky

Rukoväte zásuviek sú z hliníka



Vysoká nosnosť

4.725,00 €



FF1B01LM
Nástrčné kľúče a príslušenstvo 1/4" a 3/8"



FF1B02LM
Nástrčné kľúče a príslušenstvo 1/2"



FF1B03LM
Kľúče



FF1B04LM
Kľúče a zrkadlo



FF1B05LM
Kliešte, kľúče, nôž a meracie náradie



FF1B06LM
Skrutkovače



FF1B07LM
Momentový kľúč, skrutkovače a bity



FF1B08LM
Pilníky, skrutkovače a sekáče



FF1B09LM
Skrutkovače s T-rukoväťou, spony na hadice a páčidlá



FF1B10LM
Pílka na kov a rôzne náradie



FF1B11LM
Nástrčné kľúče a príslušenstvo 3/4"



Stiahnite si PDF Produktový list



DIELENSKÉ VOZÍKY

1472K6BKFF7SD

Dielenský vozík so 6 zásuvkami
vybavený 214 kusmi náradia

■ 3 moduly náradia 543 x 445 mm



589,00 €



Farba

Čierna

■ RAL 9005

FF1A81

Skrutkovače a kľúče



B191.040.100	⌀ 4,0x0,8x100	
B190.055.125	⌀ 5,5x1,2x125	
B190.065.150	⌀ 6,5x1x150	
B192.000.075	⊕ PH0x75	
B192.001.100	⊕ PH1x100	
B192.002.125	⊕ PH2x125	
111M	6-7-8-9-10-11-12-13-14-15-16-17-19-21-22-24 mm	
BE-9770-B	● 1,5-2-2,5-3-4-5-6-8-10 mm	

FF1A82

Úderové náradie a kliešte



3734S/6-T	⌀ 2-3-4-5-6-8 mm; 150 mm	
479-16	450 g	
3625W-35	⌀ 35 mm	
MTG-3-16	3 m; 16 mm	
KB18-01	18x161 mm	
KSB618-10 DISPEN	18 mm, x10	⌀125 x 36 mm

2101G180	180 mm	
2678G-180	⌀ 2,0; ⌀ 1,4; 180 mm	
2470G-200	200 mm	
2530	350 mm	
8224	250 mm	

Fit & go
Moduly sú k dispozícii aj jednotlivou

FF1A179

Nástrčné kľúče a príslušenstvo



● 1/4" + 1/2"

2058-BR	● 1/4", 8 mm	
59/S100B-T	● 1/4": 4,5-5,5; PH1(x2)-PH2(x9)-PH3-PH2G(x5); PZ1(x2)-PZ2(x9)-PZ3; T10(x3)-T15(x5)-T20(x15)-T25(x8)-T27-T30(x15)-T40(x3)-TR10-TR15-TR20-TR25-TR30; HEX3-HEX4(x3)-HEX5-HEX6(x3)-HEX8; R1-R2	
6950SL	● 1/4" ● 1/4" 120 mm	
8150SL	● 1/2" ● 1/2" 265 mm	
6700SM	● 1/4" 4-4,5-5-5,5-6-7-8-9-10-11-12-13-14 mm	
A6800DM	● 1/4" 7-8-9-10-11-13 mm	
6956	● 1/4" ● 1/4" 150 mm	
6961	● 1/4" ● 1/4" 100 mm	
6966	● 1/4" ● 1/4" 35 mm	

7800SM	● 1/2" ○ 10-11-12-13-14-15-16-17-18-19-20-21-22-24-27-30-34 mm	
7805DM	● 1/2" ○ 10-13-17-18-19-16-21-22 mm	
7805SM	● 1/2" ○ 16-21 mm	
8160-1/2	● 1/2" ● 1/2" 125 mm	
8162-1/2	● 1/2" ● 1/2" 250 mm	
8166-1/2	● 1/2" ● 1/2" 72 mm	
8156-1/2	● 1/2" ● 1/2" 257 mm	
7106S0080	● 1/2" ○ 5/16"	
6973	● 1/4" ○ 1/4"	
70S	● 5/16" - ● T45-T50-T55	

Dielenský vozík Séria 1472K



Vysoká nosnosť

Protišmyková gumená pracovná plocha

Plne vysúvateľné zásuvky

Ochrana hrán a rohov

Ø 125 x 36 mm

Centrálné zamykanie s rúrkovým kľúčom

- Vysoká stabilita vďaka dvojstennému vystuženému rámu
- Zvýšený okraj zabraňuje pádu náradia a iných predmetov
- K dispozícii je široká škála príslušenstva

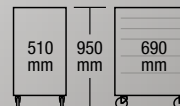

1472K6/S1

Dielenský vozík so 6 zásuvkami vybavený 177 kusmi náradia

■ 4 moduly náradia 543 x 445 mm

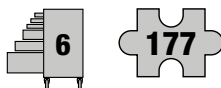

FF1A04

Kľúče



S4RM	8-11-12-15-16-19 mm	
111M	6-7-8-9-10-11-12-13-14-15-16-17-18-19-21-22-24-27-32 mm	
6M	6-7-8-9-10-11-12-13-14-15-17-19 mm	
9071C	27 mm; 208 mm / 8"	

1.499,00 €

FF1A05

Nástrčné kľúče a príslušenstvo



● 1/4" + 1/2"

BE-9678	● 1.5-2-2.5-3-4-5-6-8-10 mm	
SBS60	○ 1/4" ○ 4-4.5-5-5.5-6-7-8-9-10-11-12-13-14 mm	
SBS61	○ 1/4" - 145 mm	
SBS63-2	○ 1/4" - 50 mm	
SBS63-4	○ 1/4" - 100 mm	
SBS63-6	○ 1/4" - 150 mm	
SBS64	○ 1/4" ○ 1/4" - 125 mm	
SBS65	○ 1/4" ○ 1/4" - 32.5 mm	
SBS67	○ 1/4" - 153 mm	
SBS69	○ 1/4" ○ 3/8" - 25 mm	
SBS80	○ 1/2" ○ 10-11-12-13-14-15-16-17-18-19-21-22-24-27-30-32 mm	
SBS88	○ 1/2" ○ 3/8" - 37 mm	

FF1A06

Skrutkovače a kliešte



BE-8020L	● 0.5 x 3.0 x 75	
BE-8040	● 0.8 x 4.0 x 100	
BE-8150	● 1.0 x 5.5 x 100	
BE-8255	● 1.2 x 6.5 x 150	
BE-8256	● 1.6 x 8.0 x 150	
BE-8350	● 1.0 x 5.5 x 25	
BE-8601	● PH1 x 25	
BE-8610	● PH1 x 75	
BE-8620	● PH2 x 100	
BE-8910	● T10 x 75	
BE-8915	● T15 x 100	
BE-8920	● T20 x 100	
BE-8925	● T25 x 125	
BE-8927	● T27 x 125	
BE-8930	● T30 x 150	

FF1A07

Pilníky, úderové náradie a píla na kov



3734N	150 mm - Ø 3-5-6 mm	
3735N-4-120	120 mm - Ø 4 mm	
3740-175	175 mm - 21 mm	
SQZ150003	170 mm	
1-100-08-2-2	200 mm	
1-210-08-2-2	200 mm	
1-230-08-2-2	200 mm	
2744	190 mm	

Farba

Oranžová ■ RAL 2009

59S/31-1	● 1/4": PH1-PH2-PH3-PH2G; T25-T15-T20-T10-T27-T30; H3-H4-H5-H6; PZ1-PZ2-PZ3; 0.8x3.5-0.6x4.5-0.5x3.0; KM653-QR	
6956	○ 1/4" ○ 1/4" - 150 mm	
6972H	○ 1/4" ○ 1/4" - 26 mm	
7809M	● 1/2" - 5-6-7-8-10-12-14-17-19 mm	
7809TORX	● 1/2" - T20-T25-T27-T30-T40-T45-T50-T55-T60	
808050	○ 1/4" - 125 mm	
8150SL	○ 1/2" ○ 1/2" - 265 mm	
8154-1/2	○ 1/2" - 283 mm	
8160-W	○ 1/2" ○ 1/2" - 125 mm	
8162-1/2	○ 1/2" ○ 1/2" - 250 mm	
8166-1/2	○ 1/2" ○ 1/2" - 72 mm	

MTB-3-16	3 m; 16 mm	
2101G-160IP	160 mm	
2427 G-200 IP	200 mm	
2535L	Ø 20 mm	
2628 G-160IP	1.8; 2.0; 160 mm	
2951-180	2.0 - 180 mm	
5515T-52	Ø 30 mm; 180-690 mm	
8224 IP	250 mm	

3625W-35	Ø 35 mm; 100x300 mm	
3745-150	150 mm; 6 mm; 17x11 mm	
481-400	400 g; 112x300x25 mm	
782-U	290 mm	
317	432 mm / 17"	



Moduly sú k dispozícii aj jednotlivo

DIELENSKÉ VOZÍKY

1472K7/S1

Dielenský vozík so 7 zásuvkami
vybavený 300 kusmi náradia

■ 5 modulov náradia 543 x 445 mm



2.399,00 €

Farba

Oranžová

RAL 2009



FF1A08

Nástrčné kľúče a príslušenstvo



1/4"
3/8"
1/2"

A6800DM	1/4"	5.5-6-7-8-9-10-11-12-13 mm	
A7402DM	1/4"	10-11-12-13-14-15-16-17-18-19 mm	
1544		76 mm - 0.03-1.00 mm	
6700SM	1/4"	5.5-6-7-8-9-10-11-12-13 mm	
6709M	1/4"	3-4-5-6-8 mm	
6709PH	1/4"	PH1-PH2-PH3	
6709TORX	1/4"	T8-T9-T10-T15-T20-T25-T27-T30-T40	
6950SL	1/4"	1/4"	120 mm
6954	1/4"	1/4"	115 mm
6956	1/4"	1/4"	150 mm
6958	1/4"	153 mm	
6960	1/4"	50 mm	
6961	1/4"	101 mm	
6962	1/4"	152 mm	
6962L	1/4"	335 mm	
6966	1/4"	1/4"	35 mm
6972H	1/4"	1/4"	26 mm
7400SM	1/4"	6-7-8-9-10-11-12-13-14-15-16-17-18-19-22 mm	
7407H	1/4"	3/8"	26 mm
7409M	3/8"	3-4-5-6-7-8-10 mm	
7409TORX	3/8"	T25-T27-T30-T40-T45-T50	
7750SL	3/8"	3/8"	205 mm
7754	3/8"	3/8"	160 mm
7758	3/8"	250 mm	
7760	3/8"	75 mm	
7761	3/8"	127 mm	
7762	3/8"	252 mm	
7764	3/8"	1/4"	24,7 mm
7765	1/4"	3/8"	25 mm
7766	3/8"	3/8"	51,5 mm
7800SM	1/2"	10-11-12-13-14-15-16-17-18-19-21-22-24-27-30-32 mm	
7807H	1/4"	1/2"	38 mm
7809M	1/2"	5-6-7-8-10-12-14-17-19 mm	
7809TORX	1/2"	T20-T25-T27-T30-T40-T45-T50-T55-T60	
8150SL	1/2"	1/2"	265 mm
8154-1/2	1/2"	1/2"	283 mm
8160-1/2	1/2"	1/2"	125 mm
8162-1/2	1/2"	1/2"	250 mm
8164-1/2	3/8"	1/2"	33 mm
8165-1/2	1/2"	3/8"	37 mm
8166-1/2	1/2"	1/2"	72 mm
8964	1/2"	374"	45 mm

FF1A09

Kľúče



111M	6-7-8-9-10-11-12-13-14-15-16-17-18-19-21-22-24-27-30-32 mm	
1320RM	8-9-10-11-12-13 mm	
6M	6-7-8-9-10-11-12-13-14-15-16-17-18-19-20-22-24-27-30-32 mm	
9071C	27 mm; 208 mm / 8"	

FF1A10

Skrutkovače a meracie náradie



BE-8020L	0.5 x 3.0 x 75	
BE-8030	0.6 x 3.5 x 75	
BE-8155	1.2 x 6.5 x 125	
BE-8260	1.6 x 8.0 x 175	
BE-8350	1.0 x 5.5 x 25	
BE-8601	PH1 x 25	
BE-8602	PH2 x 25	
BE-8610	PH1 x 75	
BE-8620	PH2 x 100	
BE-8630	PH3 x 150	
BE-8910	T10 x 75	
BE-8915	T15 x 100	
BE-8920	T20 x 100	
BE-8925	T25 x 125	
BE-8927	T27 x 125	
BE-8930	T30 x 150	
BE-8940	T40 x 150	
BE-9770	1.5-2-2.5-3-4-5-6-8-10 mm	
MTB-3-16	3 m; 16 mm	
1150-1/2H/P	235 x 75 x 9	
1177-SCRIBE	70°; 230 mm	
2820EF2	200 mm	
5515T-52	30 mm; 180-690 mm	
59S/31-1	1/4"; PH1-PH2-PH3-PH2G; T25-T15-T20-T10-T27-T30; H3-H4-H5-H6; PZ1-PZ2-PZ3; 0.8x5.5-0.6x4.5-0.5x3.0; KM653-QR	
808050S	1/4"; 68 mm	
2047-0.8-4	100 mm	
2047PR-1-2	PH1-2 x 100 mm	

FF1A12

Rezacie a úderové náradie



FS-8	165 mm	
1-100-06-1-2	150 mm	
1-100-06-2-2	150 mm	
1-160-06-1-2	150 mm	
1-210-06-1-2	150 mm	
1-230-06-1-2	150 mm	
2509	525 mm	
2535F2	10 mm; 535 mm	
3625W-35	35 mm; 100x300 mm	
3734	150 mm - 3-5-8 mm	
3735-4-120	120 mm - 4 mm	
3740-150	150 mm - 18 mm	
3745-150	150 mm - 6 mm	
481-300	300 g; 105x300x23 mm	
481-500	500 g; 118x300x27 mm	
8158-1/2	1/2"; 390 mm	
319	300 mm / 11"	

FF1A11

Kliešte



2101GC-125IP	125 mm	
2101GC-160IP	160 mm	
21HDC-200IP	200 mm	
2427 GC-200IP	200 mm	
2430 GC-200 IP	200 mm	
2628 GC-160IP	2.0; 1.8; 160 mm	
2928	160-200-250 mm	
2951-250	3.0 - 250 mm	
2952-165	165 mm	
8224CIP	250 mm	



Moduly sú k dispozícii aj jednotlivé



Vhodné pre Fit&Go moduly náradia

Stabilná, pohodlná rukoväť pre jednoduché manévrowanie



Veľmi vysoká nosnosť



NOVINKA

Mobilná dielňa pre prepravné spoločnosti a sklady

1475KXXL8CWTSS

Mobilný, robustný dielenský vozík s 8 zásuvkami a bočnou skrinkou, bez náradia



- Dvojstenný vystužený rám chráni zásuvky v prípade kolízie
- Maximálne využitie vďaka úplnému vysunutiu a optimálnej výške zásuviek
- Centrálny zámok a zabezpečenie jednotlivých zásuviek

2.945,00 €

Farba
Oranžová RAL 2009

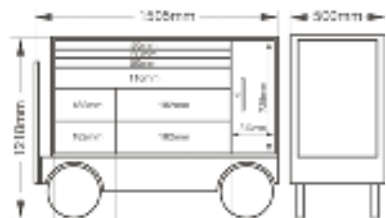

Vnútročné rozmery zásuviek:
(3x) 827 mm x 445 mm x 50 mm,
(1x) 827 mm x 445 mm x 116 mm,
(2x) 284 mm x 445 mm x 182 mm,
(2x) 543 mm x 445 mm x 182 mm

Skrinka
313 mm x 445 mm x 725 mm



Skrinka so samostatným zámkom



Extra veľké gumové kolesá 320 x 85 mm pre použitie v nerovnom teréne



Spodná zásuvka pre ďalší úložný priestor



Pracovná doska z nehrdzavejúcej ocele

DIELENSKÉ VOZÍKY

1477K7COLORS

Dielenský vozík so 7 zásuvkami, bez náradia



Veľmi vysoká nosnosť

779,00 €



NOVINKA

- Vysoká stabilita vďaka dvojstennému vystuženému rámu
- Dokonalá bezpečnosť práce vďaka centrálnemu zamykaniu a ochrane zásuviek voči nechcenému otvoreniu pri manévrovaní s vozíkom
- Flexibilné možnosti zostavenia vozíka pomocou rozsiahleho príslušenstva



Vnútročné rozmery zásuviek:
(5x) 543 x 445 x 53 mm
(1x) 543 x 445 x 118 mm
(1x) 543 x 445 x 249 mm



Plastová pracovná plocha s priehradkami na malé súčiastky



Ochrana hrán na každej zásuvke



Plne vysúvateľné zásuvky



Ø 125 x 36 mm

Plná mobilita a tichý chod vďaka dvom pevným a dvom otočným kolieskam z pevnej gumeny

1471KXXL12BKTTSS

Veľký dielenský vozík s 12 zásuvkami, bez náradia



Veľmi vysoká nosnosť

Dvojstenný vystužený rám chráni zásuvky v prípade kolízie

NOVINKA

- Centrálny zámok a zabezpečenie jednotlivých zásuviek
- Plne vysúvateľné zásuvky
- Plná mobilita a tichý chod vďaka dvom pevným a dvom otočným kolieskam z pevnej gumeny
- Flexibilné možnosti zostavenia vozíka pomocou rozsiahleho príslušenstva

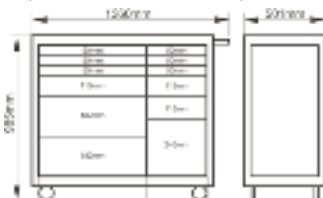

Vnútročné rozmery zásuviek:
(3x) 880 x 445 x 50 mm (3x) 313 x 445 x 50 mm
(1x) 880 x 445 x 116 mm (2x) 313 x 445 x 116 mm
(2x) 880 x 445 x 182 mm (1x) 313 x 445 x 246 mm



■ Pracovná doska z nehrdzavejúcej ocele

1.975,00 €



PRÍSLUŠENSTVO

Príslušenstvo pre sériu 1472K / 1477K

1472K-ACTD

26" Pracovná doska z MDF



1472K-ACTSS

26" Pracovná doska z nehrdzavejúcej ocele



1472K-ACTW

26" Pracovná doska z dreva



1477K-AC18

Držiak rolne papiera



1477K-AC19

Bočná priehradka na dokumenty



1477K-AC20

Držiak pre spreje, plechovky



1477K-AC21

Držiak pre pneumatické náradie



1477K-AC22

Perforovaná bočná stena



1477K-AC26

Rozdeľovače zásuviek



Kód výrobku	Popis	€
1472K-ACTD	Pracovná doska z MDF	125,00
1472K-ACTSS	Pracovná doska z nehrdzavejúcej ocele	199,00
1472K-ACTW	Pracovná doska z dreva	169,00
1477K-AC18	Držiak rolne papiera	41,55
1477K-AC19	Bočná priehradka	36,90
1477K-AC20	Držiak pre spreje, plechovky	32,30
1477K-AC21	Držiak pre pneumatické náradie	69,20
1477K-AC22	Perforovaná bočná stena	50,75
1477K-AC26	Rozdeľovače zásuviek (sada 15 ks)	40,80

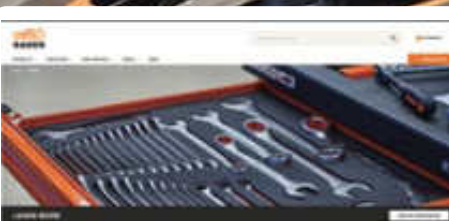

BETMS Konfigurátor
bahco.com/sk_sk/betms

PENOVÉ MODULY S NÁRADÍM

FF1ASET-AUTO1

5 penových modulov s náradím na opravy a údržbu vozidiel

196

1.315,00 €

- 3/3 moduly náradia 543 x 445 mm
- Vhodné pre všetky dielenské vozíky Bahco

fit&go SYSTEM
Moduly sú k dispozícii aj jednotlivo



FF1A19
Kľúče

33

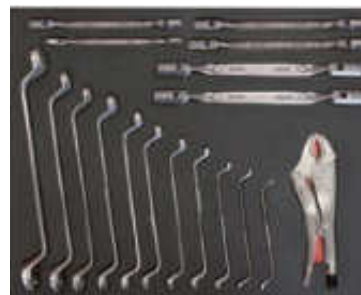

FF1A20
Kľúče a pridržiavacie kliešte

18

Stiahnite si PDF Produktový list



FF1A21
Skrutkovače a bity

66



FF1A22
Nástrčné kľúče a príslušenstvo 1/2" a 1/4"

58



FF1A23
Kliešte a úderové náradie

21

FF1ASET-AUTO6

4 penové moduly s náradím na opravy a údržbu vozidiel

199

769,00 €

- 3/3 moduly náradia 543 x 445 mm
- Vhodné pre všetky dielenské vozíky Bahco

Stiahnite si PDF Produktový list



FF1A19
Kľúče

33



FF1A70
Nástrčné kľúče a príslušenstvo 1/2" a 1/4"

102



fit&go SYSTEM
Moduly sú k dispozícii aj jednotlivo



FF1A71
Skrutkovače a bity

46



FF1A72
Kliešte a úderové náradie

18

FF1ASET-MAX

4 penové moduly s náradím na opravy a údržbu vozidiel

■ 3/3 moduly náradia

195

1.035,00 €

543 x 445 mm

■ Vhodné pre všetky dielenské vozíky Bahco

Stiahnite si PDF
Produktový list

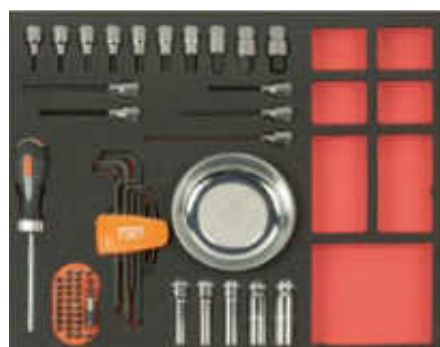

Penové moduly s náradím: Šité na mieru. Zamerané na používateľa.

Naše systémy na ukladanie náradia sú výsledkom našich mnohoročných skúseností v spolupráci s ich používateľmi a partnermi z letectva a priemyslu – prispôsobené a navrhnuté tak, aby uľahčili každodennú prácu.

- Pasujú do všetkých mobilných dielenských vozíkov Bahco a pracovných stolov Bahco
- Veľký výber modulov

fit & go
SYSTEM



Odolné voči: voda,
skydrol, benzín



Odolné voči
ÚV žiareniu



Tlmič
nárazov

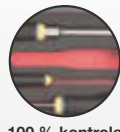

100 % kontrola
2-farebná pena



Systém
zatláčenia (Push)

Kompletný sortiment modulov s náradím nájdete – v online Bahco katalógu

Vybavte si vaše dielenské vozíky s náradím. Na výber máme z viac ako **200 modulov** s rôznym náradím v rôznych veľkostiach modulov 1/3, 2/3 a 3/3.



1/3 181 x 445 mm

2/3 362 x 445 mm

3/3 543 x 445 mm



VYBAVENIE AUTOSERVISU

BLE301
Pojazdné montážne ležadlo

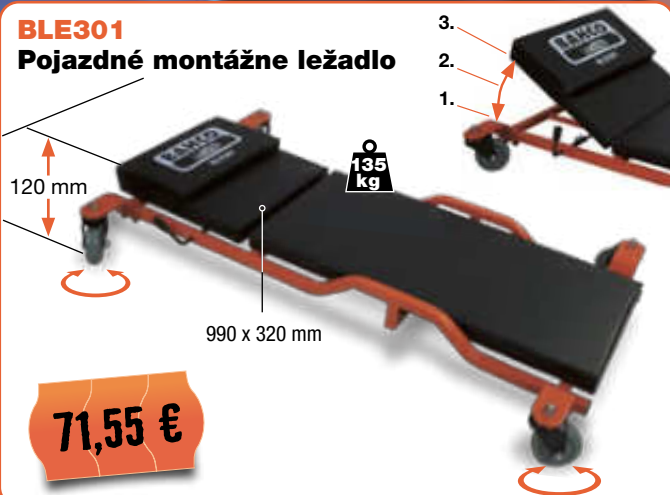

71,55 €

BLE304
Pojazdné skladacie montážne ležadlo a stolička

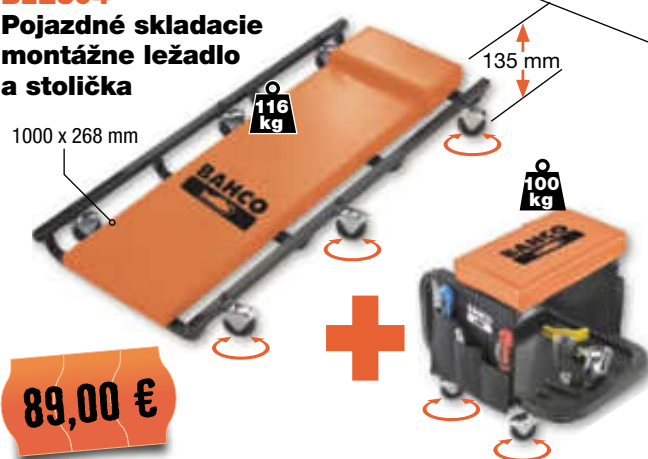

89,00 €



BLE300
Dielenská stolička so zásuvkami

102,25 €



BLE305
Odpružená pneumatická dielenská stolička

92,00 €

5750
Poťah sedadla



■ Nylón, odolný voči kvapalinám, ľahko umývateľný

10,10 €

B147.001.400
Flexibilný magnetický držiak

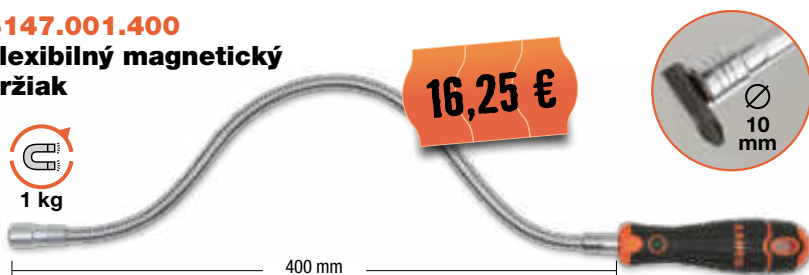

16,25 €

BMD150
Magnetická miska



6,65 €

BLEMAT1 Multifunkčný stôl

- Ideálny na údržbárske práce na vozidle
- Adaptabilný tvar konštrukcie umožňuje predný a bočný prístup k vozidlu
- Ochranné lišty v hornej polici a na ráme, aby sa zabránilo poškodeniu v prípade kolízie s karosériou vozidla



Kompatibilný s penovými modulmi Fit & Go

Panel na náradie kompatibilný s hákmi a príslušenstvom BAHCO

50 kg

Veľká rukoväť uľahčuje manipuláciu

245,00 €

NOVINKA



59,00 €

BLEMAT1BT Spodná polica pre BLEMAT1

- Na prenášanie pneumatík a iných ťažkých dielov

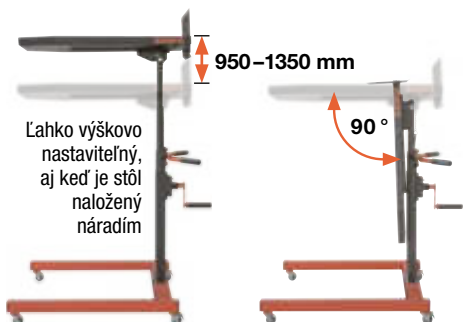

Lahko výškovo nastaviteľný, aj keď je stôl naložený náradím

950–1350 mm

90°

115 mm

1470KC2 Dielenský servisný vozík s dvoma policami

1051 x 764 x 435 mm

Stabilný rám v tvare U vyrobený z hliníka

139,00 €



Ø 100 x 25 mm

Vnútoré rozmery polic: 750 x 425 x 77 mm

50 kg

50 kg

1470KC3 Dielenský servisný vozík s tromi policami

1051 x 764 x 435 mm

Stabilný rám v tvare U vyrobený z hliníka

149,00 €

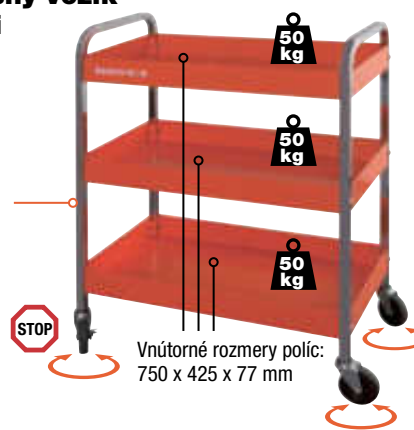

Vnútoré rozmery polic: 750 x 425 x 77 mm

50 kg

50 kg

50 kg

1470KC5 Multifunkčný dielenský servisný vozík s tromi zásuvkami, dvoma policami a ďalšou sklopnou poličkou

- 3 zásuvky s dostatkem úložného priestoru
- Kliknutím na uzamykací systém zacvaknete na miesto
- S guľkovými ložiskami na úplné otvorenie zásuviek
- Zásuvky sa dajú uzamknúť z hornej police

1051 x 1381 x 435 mm

369,00 €

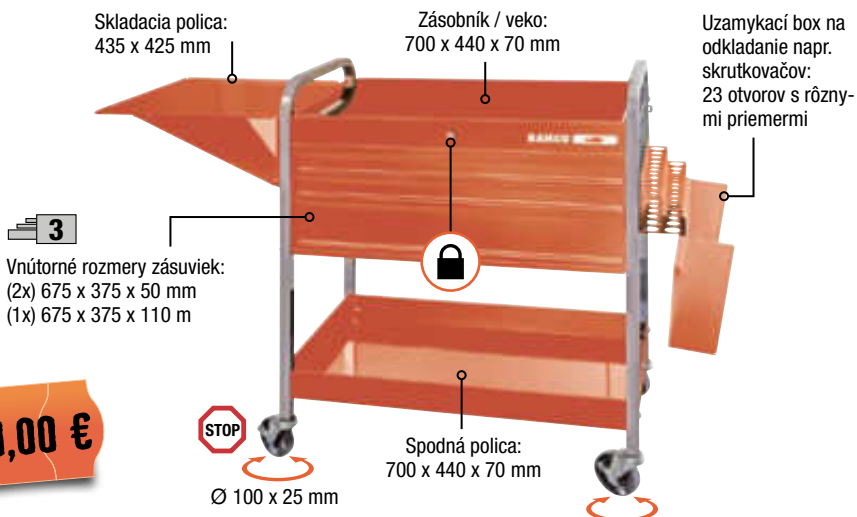

Skladacia polica: 435 x 425 mm

Zásobník / veko: 700 x 440 x 70 mm

Uzamykací box na odkladanie napr. skrutkovačov: 23 otvorov s rôznymi priermi

Vnútoré rozmery zásuviek: (2x) 675 x 375 x 50 mm (1x) 675 x 375 x 110 mm

Spodná polica: 700 x 440 x 70 mm

Ø 100 x 25 mm

HYDRAULICKÉ NÁRADIE A ZDVIHÁKY

Zdvihák

- Dvojitý piest umožňuje až o 50 % rýchlejšie zdvíhanie



Video návody na použitie a údržbu



BAHCO	T	▲ mm	▲ mm	← mm →	kg	€
BH11500	1,5	70	610	945	51	265,00
BH12000	2	70	490	790	45	235,00
BH13000	3	90	552	820	51	245,00

Hliníkový zdvihák

- Veľmi ľahký a ideálny pre mobilné použitie

- Dvojitý piest na rýchle zdvíhanie



NOVINKA



BAHCO	T	▲ mm	▲ mm	← mm →	kg	€
BH1A1500A	1,5	85	415	542	12,8	215,00
BH1A2500A	2,5	100	485	665	24,4	330,00

BH1CB1000

Priečny nosník pre zdvihák

96,00 €

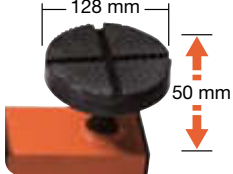

BH13000QA

Zdvihák s funkciou rýchleho zdvihu, 3 tony

- Nový zdvíhací mechanizmus: iba 5 zošliapnutí na dosiahnutie maximálnej výšky



5x



NOVINKA

BH13000L

Zdvihák, 3 tony



- Dvojitý piest na rýchle zdvíhanie
- Dlhé šasi umožňuje hlboké zasunutie zdvíhaka pod vozidlo



BH15000A

Zdvihák, extra dlhý, 5 ton



BH110000A

Zdvihák, extra dlhý, 10 ton



BH110000A-EXT

Predlžovací nástavec sedla, 10 ton



80,00 €

- Na zvýšenie výšky zdvihu
- Dodáva sa s 10 mm imbusovým kľúčom pre montáž



BH1S45
Nožnicový zdvíhák

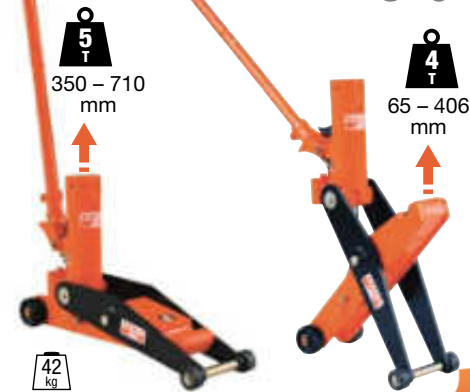

- Dvojpohová zdvíhacia päťka umožňuje manipuláciu s vysokozdvížnymi vozíkmi s plochými alebo hranatými povrchmi



510,00 €

HYDRAULICKÉ NÁRADIE A ZDVIHÁKY

Hydro-pneumatický zdvihák pre najťažšie práce



BH23015C Kompaktný zdvihák, 30 ton

- Ideálny pre poruchové služby vďaka svojej kompaktnej veľkosti, odnímateľnej páke a mäkkej prepravnej rukoväti



30 T
Dodáva sa s dvoma adaptérmi na ďalšie zvýšenie výšky zdvihu:
45 mm + 75 mm

BH28050 80 ton

- Mimoriadne robustný a vhodný pre veľmi ťažké vozidlá

NOVINKA



80 T
Dodáva sa s dvoma adaptérmi na ďalšie zvýšenie výšky zdvihu:
45 mm + 75 mm

BH2402010 40 ton



40 T

BH2604020 60 ton

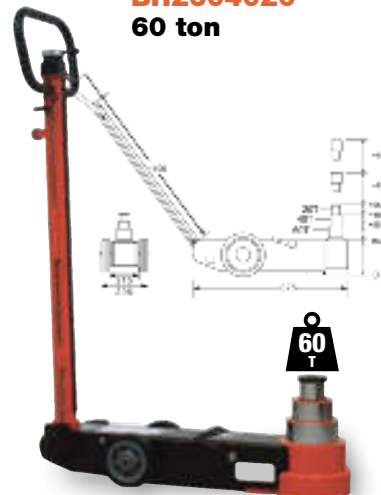

60 T

- Veľké kolieska z PU ľahko prekonávajú prekážky, ako sú hadice a káble
- Vodiace koleso na páke zabraňuje zraneniu a umožňuje lepšiu ovládateľnosť zdviháka
- Dodáva sa s dvoma adaptérmi na ďalšie zvýšenie výšky zdvihu
- CE certifikácia podľa 2006/42 / EG a BS EN1494



BAHCO	mm	1 mm	2 mm	3 mm	kg	€
BH23015C	150	224 / 30 t	292 / 15 t	—	35	868,00
BH2402010	125	183 / 40 t	233 / 20 t	287 / 10 t	52	1.399,00
BH2604020	150	206 / 60 t	255 / 40 t	310 / 20 t	71	1.585,00
BH28050		341 / 80 t	443 / 50 t	—	108	1.999,00

Zdvíhacie podpery

BH33000 3 tony

- 1 pár
- So zaistovacím čapom

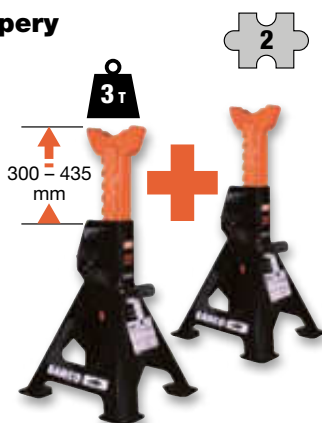

3 T
300 = 435 mm

35,00 €

BH36000 6 ton

- 1 pár
- So zaistovacím čapom

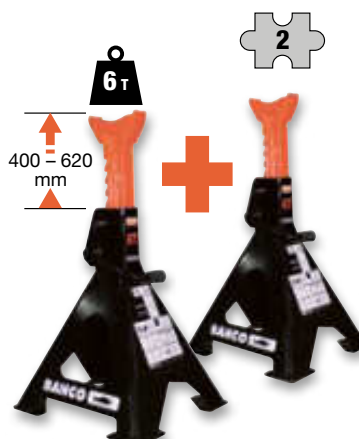

6 T
400 = 620 mm

66,00 €

Automatický zdvihák

BH3A3000 3 tony

- 1 pár
- Jednoduché ovládanie jednou rukou
- Dodatočný bezpečnostný kolík



Zdvihák sa vytiahnutím páky automaticky zdvíha nahor vďaka pružine



BH3A5000 5 ton

- 1 pár
- Jednoduché ovládanie jednou rukou
- Dodatočný bezpečnostný kolík

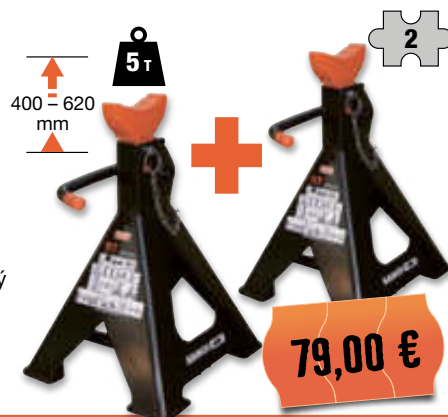

Zdvíhacie podpery pre väčšie zaťaženie

BH3HD8000 8 ton



- So zaistovacím čapom

BH3HD16000 16 ton



- So zaistovacím čapom

BH3HD12000 12 ton



- Presné nastavenie výšky pomocou závitú

BH3HD20000A 20 ton



- So zaistovacím čapom

BH4- Stĺpkový zdvihák



- S poistným ventilom
- Dvojité zvarané puzdro pre vysokú nosnosť a tesnosť
- Dodatočné nastavenie výšky pomocou skrutkovaného sedla



BH4S- Stĺpkový zdvihák

- S poistným ventilom
- Dvojité zvarané puzdro pre vysokú nosnosť a tesnosť
- Dodatočné nastavenie výšky pomocou skrutkovaného sedla

BAHCO	T	mm	mm	kg	€
BH42	2	174	369	3,8	38,00
BH45	5	212	467	5,1	51,00
BH410	10	220	483	7,4	67,00
BH415 *	15	231	498	9,7	88,00
BH420 *	20	241	521	13,2	117,00
BH430 *	30	244	492	16,3	158,00

BAHCO	T	mm	mm	kg	€
BH4S2	2	168	316	2,0	16,50
BH4S4	4	188	363	2,8	19,90
BH4S6	6	207	402	3,7	23,80
BH4S8	8	222	447	4,8	38,20
BH4S12 *	12	227	457	6,0	39,75
BH4S20 *	20	235	445	8,6	63,65
BH4S50 *	50	280	450	26,0	155,00

* s rukoväťou

BH4HP50 Pneumaticko hydraulický stĺpkový zdvihák, 50 t

NOVINKA

- Stabilná zvaraná konštrukcia



300 - 470 mm



- Ľahké a rýchle ovládanie pomocou pneumatického pripojenia
- Dá sa ovládať aj čisto hydraulicky

445,00 €

HYDRAULICKÉ NÁRADIE A ZDVIHÁKY

BH5SP500QASET

Hydraulický zdvihák prevodoviek s univerzálnym sedlom, 500 kg - set

- Používa sa pod zdvihnutými vozidlami na bezpečné odstraňovanie, montáž alebo transport prevodoviek
- Gyroskopické nastaviteľné univerzálne sedlo
- Rýchle dosiahnutie úplnej výšky po 38 zdvihoch vďaka dvojrychlostnej pumpe
- Odpružený znižovací mechanizmus

NOVINKA

- Široká základňa pre vyššiu stabilitu pri zdvíhaní a manévrovaní



399,00 €

Možnosti dodania s:

A Štandardné sedlo

B Gyroskopické nastaviteľné univerzálne sedlo

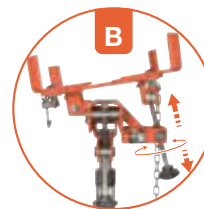
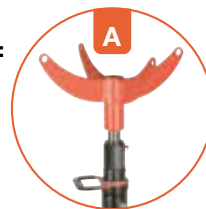

BH5DP1000QA

Hydraulický zdvihák prevodoviek, 1000 kg

- Používa sa pod zdvihnutými vozidlami na bezpečné odstraňovanie, montáž alebo transport prevodoviek
- Rýchle dosiahnutie úplnej výšky po 36 zdvihoch vďaka dvojrychlostnej pumpe
- Zdvíhanie bremena pomocou nožného pedálu, čím sa uvoľnía ruky

499,00 €

- Široká základňa pre vyššiu stabilitu pri zdvíhaní a manévrovaní



Sedlo je možné pripevniť aj opačne

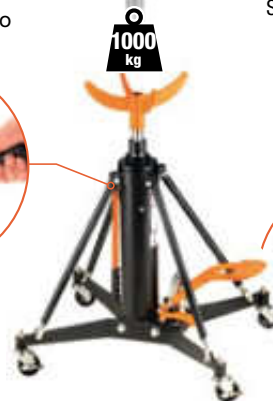

Ø 75 mm



BH8AC2-500 Otočný stojan na motor, 500 kg

- Pre ľahkú údržbu motora
- Ľahké otáčanie prevodom pomocou kľuky
- Skladacia kľuka



285,00 €

BH1CD680 Manévrovací vozík

- Na ľahké zdvíhanie a manévrovanie s osobnými alebo ľahkými užitkovými vozidlami
- Rukoväť potiahnutá PVC



119,00 €

BH1CD680SET Manévrovací vozík - set



- 4 manévrovacie vozíky + stojan na ich odkladanie
- Šetrí miesto pri skladovaní a uľahčuje transport

479,00 €



LISY A ŽERIAVY

Dielenské lisy

- Navijak s otočnou rukoväťou pre jednoduchšiu manipuláciu s lisom
- Robustný zváraný rám so stabilnou základňou

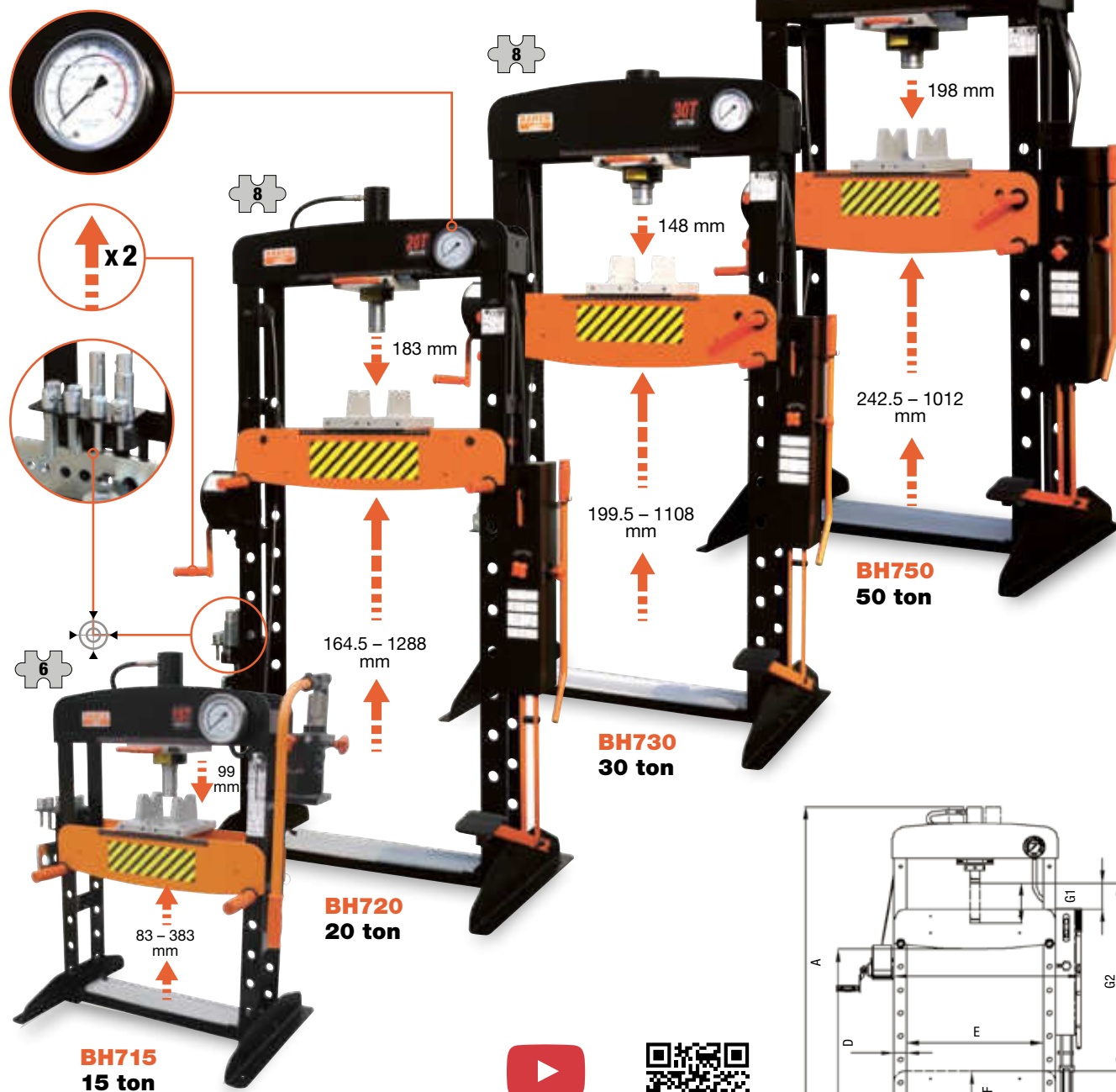

Video návody na použitie a údržbu



BAHCO	↕	A mm	B mm	C mm	D mm	E mm	F mm	G1 mm	G2 mm	kg	€
BH715	15 t	970	695	500	383	495	83	99	399	80	785,00
BH720	20 t	1885	880	650	1288	645	164.5	43	1143	151	1.190,00
BH730	30 t	1810	960	700	1108	695	199.5	140	1020	189	1.585,00
BH750	50 t	1855	1000	770	1012	725	242.5	173	1013	309	1.849,00

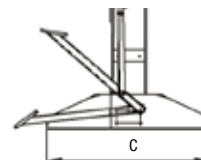

BH7PS30 Podporná dierovaná doska

- Na jednoduchú a bezpečnú montáž alebo demontáž ložísk, nábojov kolies, puzdiar atď.
- Vhodná pre dielenské lisy Bahco: BH715, BH720, BH730 a BH750

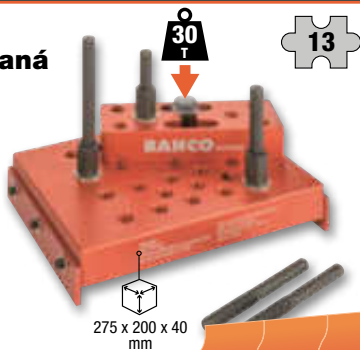

275 x 200 x 40 mm

225,00 €

NOVINKA

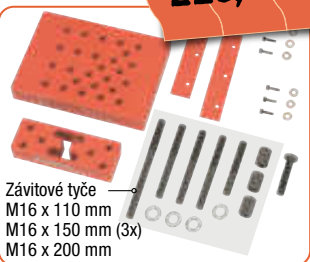

Závitové tyče
M16 x 110 mm
M16 x 150 mm (3x)
M16 x 200 mm

Ochranná mriežka

- Vhodná pre dielenské lisy Bahco: BH720, BH730 a BH750
- Na ochranu pred odletujúcimi časťami pri zlomení alebo vyskočení dielu pri lisovaní
- Jednoduchá montáž iba 4 skrutkami
- Vyrobené z hliníka

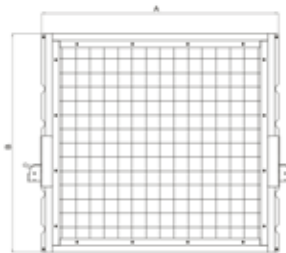

BAHCO	A mm	B mm	€
BH720SG	515	520	99,00
BH730SG	485	520	105,00
BH750SG	675	625	125,00

Skladací žeriav

- „Dead man“ bezpečnostný mechanizmus
- Ventil proti preťaženiu

- Dvojitý valec umožňuje o 50% rýchlejšie zdvíhanie
- CE-certifikovaný podľa 2006/42/EC a BS EN1494

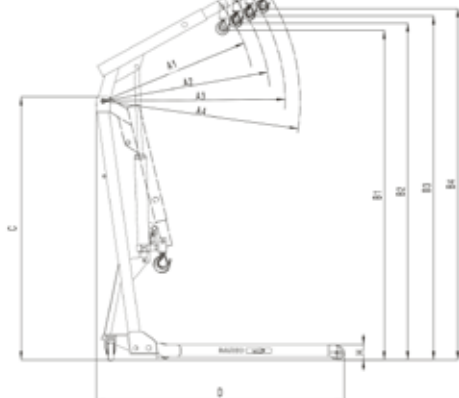

Video návody na použitie a údržbu



BAHCO	📦	A1 kg	A2 kg	A3 kg	A4 kg	B4 mm	C mm	D mm	H mm	📦 kg	€
BH6FC1000	1 t	1000	750	500	250	2175	1578	1480	88	85	439,00
BH6FC2000	2 t	2000	1500	1000	500	2640	1880	1845	130	170	799,00

BH6AC1-680A Manipulačné rameno na motor

- Vhodné pre BH6FC1000 a BH6FC2000

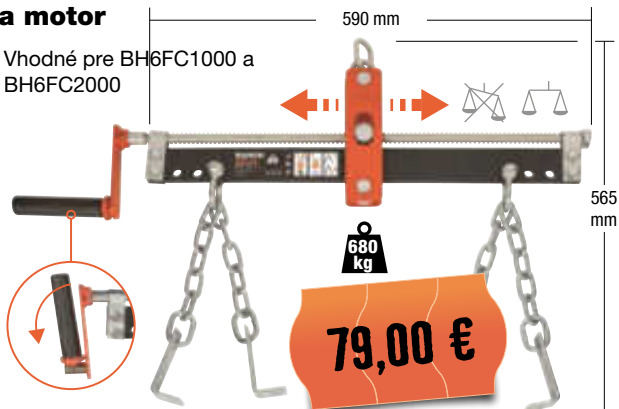

79,00 €

BH8AC1-500 Manipulačné rameno na motor



89,00 €

- Vhodné pre všetky vozidlá vrátane veľkých SUV; Audi Q7, BMW X5, Porsche Cayenne, VW Touareg

RUČNÉ NÁRADIE

BE1TS-S7

Sada nástrčných klúčov s kĺbom a T-rukoväťou



7 8 10 12 13 14 17 mm



3/8"



112,40 €

Sady skrutkovačou s T-rukoväťou

903T-1



Krátka 90° čepeľ na uťahovanie/povoľovanie s vysokým krútiacim momentom v miestach s obmedzenou výškou.

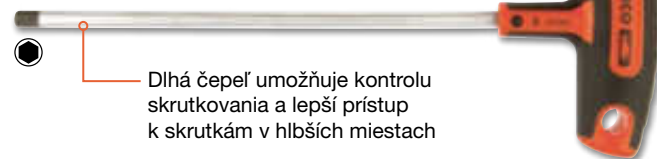

Dlhá čepeľ umožňuje kontrolu skrutkovania a lepší prístup k skrutkám v hlbších miestach

903T-2



Krátka 90° čepeľ



2-zložková rukoväť

903T-3



BAHCO			€
903T-1	● Šesťhran	3, 4, 5, 6, 8, 10 mm	51,00
903T-2	★ TORX®	T10, T15, T20, T25, T30, T40	42,55
903T-3	○ Nástrčný kľúč	5, 6, 7, 8, 10, 13 mm	64,25

BE1TH-S6

Sada klúčov na skrutky s vnútorným 6-hranom s T-rukoväťou

45,90 €



● 2.5 3 4 5 6 8 mm



3625PU-

Bezodrazové kladivo



-20°C – +90°C



PU



83-86 Shore A

BAHCO	mm	mm	g	€
3625PU-30	300	35	300	18,30
3625PU-50	340	50	640	23,40
3625PU-60	400	60	1080	30,55

158-N

Kliešte s dlhými špicatými čelustami

■ Extra dlhé



22,95 €

1467-250

Nitovacie kliešte



■ So 4 vymeniteľnými hlavami: Ø 2,4 / 3,2 / 4 / 4,8 mm

28,50 €

158-NB

Kliešte s dlhými zahnutými špicatými čelustami

■ Extra dlhé, zahnuté



22,95 €

SADY NÁSTRČNÝCH KLÍČOV



24,00 €

SL25AF

Sada nástrčných klíčov,  25
Palcové rozmery

● 1/4"

- Palcové rozmery
- Vysoko výkonná legovaná oceľ, matný povrch
- ISO 1174/DIN 3120



Bahco
Online-
Katalóg >



- 1/4" ○ 1/8" 5/32" 3/16" 7/32" 1/4" 9/32" 5/16" 11/32" 3/8" 7/16" 1/2" 9/16"
- 1/4" 60 zubov, uhol záberu 6°
- 1/4" 100 mm
- 1/4" ○ 1/4"
- T10 15 20 25 30 40
- 7/32" 1/4" PH 1 2



42,00 €

S330AF

Sada nástrčných klíčov,  34
Palcové rozmery

● 1/4" + 3/8"

- Palcové rozmery
- Vysoko výkonná legovaná oceľ, matný povrch
- ISO 1174/DIN 3120



Bahco
Online-
Katalóg >



- 3/8" ○ 1/4" 5/16" 11/32" 3/8" 7/16" 1/2" 9/16" 5/8" 11/16" 3/4" 13/16" 7/8"
- 3/8" 60 zubov, uhol záberu 6°
- 3/8" 75 & 150 mm
- 3/8"
- 3/8" ○ 1/4"
- 1/4" ○ 1/4"
- 1/4"
- 3/16" 7/32" 9/32"
- PH 1 2 3 4
- H 1/8" 5/32" 3/16" 7/32" 1/4" 5/16"



75,00 €

S240AF

Sada nástrčných klíčov,  24
Palcové rozmery

● 1/2"

- Palcové rozmery
- Vysoko výkonná legovaná oceľ, matný povrch
- ISO 1174/DIN 3120



Bahco
Online-
Katalóg >



- 1/2" ○ 1/8" 3/8" 7/16" 1/2" 9/16" 5/8" 11/16" 3/4" 13/16" 7/8" 15/16" 1" 1.1/16" 1.1/8" 1.3/16" 1.1/4"
- 1/2" 60 zubov, uhol záberu 6°
- 1/2" 250 mm
- 1/2" 125 & 150 mm
- 1/2"



- Kufor z vysoko odolného polyetylénu HDPE; odolný voči nárazom, olejom a teplotám



119,00 €

S910AF
Sada nástrčných klúčov,
Palcové rozmery



91

1/4" + 1/2"

- Palcové rozmery
- Vysoko výkonná legovaná oceľ, matný povrch
- ISO 1174/DIN 3120

Bahco
Online-
Katalóg >



1/4"	1/8", 5/32", 3/16", 7/32", 1/4", 9/32", 5/16", 11/32", 3/8", 7/16", 1/2", 9/16", 5/8", 11/16"
1/4"	5/32", 3/16", 7/32", 1/4", 9/32", 5/16", 11/32", 3/8", 7/16", 1/2"
1/4"	60 zubov, uhol záberu 6°
1/4"	
1/4"	75 & 150 mm
1/4"	
1/2"	1/2", 9/16", 5/8", 11/16", 3/4", 13/16", 7/8", 15/16", 1", 1.1/16", 1.3/16"
1/2"	13/16" (21 mm)
1/2"	60 zubov, uhol záberu 6°
1/2"	250 mm
1/2"	125 & 150 mm
1/2"	
1/4"	1/4"
1/2"	1/2"
1/4"	1/4"
1/4"	1/4"
1/4"	3/16" 7/32" 9/32" 1/4" PH 0 1 2 3 4
1/4"	H 1/8" 5/32" 3/16" 7/32" 1/4" 5/16"
1/4"	T8 T10 T15 T20 T25 T27 T30 T40
5/16"	T45 T50 T55
5/16"	5/16", 3/8", 7/16", 1/2", 9/16", 11/16"
5/16"	9/16"-19/32", 15/32"-1/2", 3/8"-7/16", 5/16"-11/32"
1/16"	5/64" 3/32"



97,20 €

S530T
Sada nástrčných klúčov
s priechodnou račňou

53

- Priechodná obojsmerná račňa pre dlhé závit, 3/8" (19 mm), 72 zubov
- Metrické rozmery
- Vysoko výkonná legovaná oceľ, matný povrch



S prepínacou páčkou



10 11 12 13 14 15 16 17 19 21 22 24
8 9 10 11 12 13 14 15 16 17
E8 E10 E11 E12 E14 E16 E18 E20 E22
3/8" 72 zubov
3/8" 75
3/8" 1/4" & 3/8" & 1/2"
3/8" 1/4" & 5/16"
5/16" M 7 8 10 12 mm
5/16" TTX 40H 45H 50H 55H
1/4" M 5 6 mm
1/4" TTX 20H 25H 27H 30H

SADY NÁSTRČNÝCH KLÍČOV



18

S18HEX

Sada nástrčných klíčov s výstupom na skrutky

1/2" Šesťhran

- Vysoko výkonná legovaná oceľ, matný povrch
- ISO 1174/DIN 3120

69,95 €

● M 4 5 6 7 8 10 12 14 17	←mm→ 60
● M 4 5 6 7 8 10 12 14 17	←mm→ 130



24,95 €

9

S9HEX

Sada nástrčných klíčov s výstupom na skrutky

1/2" Šesťhran

- Vysoko výkonná legovaná oceľ, matný povrch
- ISO 1174/DIN 3120

● M 4 5 6 7 8 10 12 14 17



18

S18TORX

Sada nástrčných klíčov s výstupom na skrutky TORX

1/2" TORX®

- Vysoko výkonná legovaná oceľ, matný povrch
- ISO 1174/DIN 3120

57,95 €

● T20 T25 T27 T30 T40 T45	←mm→ 60
● T50 T55 T60	
● T20 T25 T27 T30 T40 T45	←mm→ 130
● T50 T55 T60	



22,95 €

9

S9TORX

Sada nástrčných klíčov s výstupom na skrutky TORX

1/2" TORX®

- Vysoko výkonná legovaná oceľ, matný povrch
- ISO 1174/DIN 3120

● T20 T25 T27 T30 T40 T45 T50 T55 T60





NOVINKA



Sady nástrčných klúčov s račnou s výkvnou hlavou

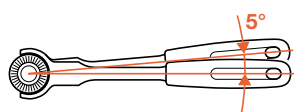

- Metrické rozmery
- Vysoko výkonná legovaná oceľ, matný povrch
- ISO 1174/DIN 3120
- Račňa: 72 zubov



SW65

1/4"



DYNAMIC-DRIVE™

69,00 €

- 1/4" ○ 4 4.5 5 5.5 6 7 8 10 11 12 13
- 1/4" ○ 1/4"
- 1/4" ○ 1/4"
- 1/4" ○ 75 & 150 mm
- 3/8" □ 1/4"
- 1/4" □ 1/4"
- ⊕ ← 2xPH1 2xPH2
- ⊕ ← 2xPZ1 2xPZ2
- ⊕ ← T10 T15 T20 2xT25 2xT27 2xT30
- ← H 3 4 5 6
- 1/4" ○ 1/4" ● 1/4" □ 1/4"
- SL 4 5.5 7
- ⊕ ← PH0 PH1 PH2 PH3 PH4
- ⊕ ← PZ1 PZ2 PZ3
- ⊕ ← T8 T10 T15 T20 T25 T27 T30
- ← H 3 4 5 6



SW79

1/4" + 1/2"



DYNAMIC-DRIVE™

119,00 €

- 1/4" ○ 4 4.5 5 5.5 6 7 8 10 11 12 13
- 1/4" ○ 1/4"
- 1/4" ○ 1/4"
- 1/4" ○ 75 & 150 mm
- 1/2" ○ 10 11 12 13 15 16 17 18 19 21 22 23 24 27
- 1/2" ○ 1/2"
- 1/2" ○ 125 & 250 mm
- 3/8" □ 1/2"
- 1/4" □ 1/4"
- ⊕ ← PH1 PH2
- ⊕ ← PZ1 PZ2
- ⊕ ← T10 T15 T20 T25 T27 T30
- ← H 3 4 5 6
- 1/4" ○ 1/4" ● 1/4" □ 1/4"
- SL 3.0, 4.5, 5.5
- ⊕ ← 1xPH1, 4xPH2, 1xPH3, 2xPH2G
- ⊕ ← 1xPZ1, 4xPZ2, 1xPZ3
- ⊕ ← 1xT10, 2xT15, 2xT20, 1xT25, 1xT27, 2xT30
- ← H 3 4 5 6



SW91

1/4" + 3/8"



DYNAMIC-DRIVE™

119,00 €

- 1/4" ○ 4 4.5 5 5.5 6 7 8 10 11 12 13
- 1/4" ○ 1/4"
- 1/4" ○ 1/4"
- 1/4" ○ 75 & 150 mm
- 3/8" ○ 8 10 11 12 13 15 16 17 18 19 21
- 3/8" ○ 1/4"
- 3/8" ○ 75 & 150 mm
- 3/8" □ 1/4"
- 3/8" □ 1/4"
- ⊕ ← 2xPH1 2xPH2
- ⊕ ← 2xPZ1 2xPZ2
- ⊕ ← 2xT10 2xT15 2xT20 2xT25 2xT27 2xT30
- ← 2xH3 2xH4 2xH5 2xH6
- 1/4" ○ 1/4" ● 1/4" □ 1/4"
- SL 3.0, 4.5, 5.5
- ⊕ ← 1xPH1, 4xPH2, 1xPH3, 2xPH2G
- ⊕ ← 1xPZ1, 4xPZ2, 1xPZ3
- ⊕ ← 1xT10, 2xT15, 2xT20, 1xT25, 1xT27, 2xT30
- ← H 3 4 5 6

KLÚČE

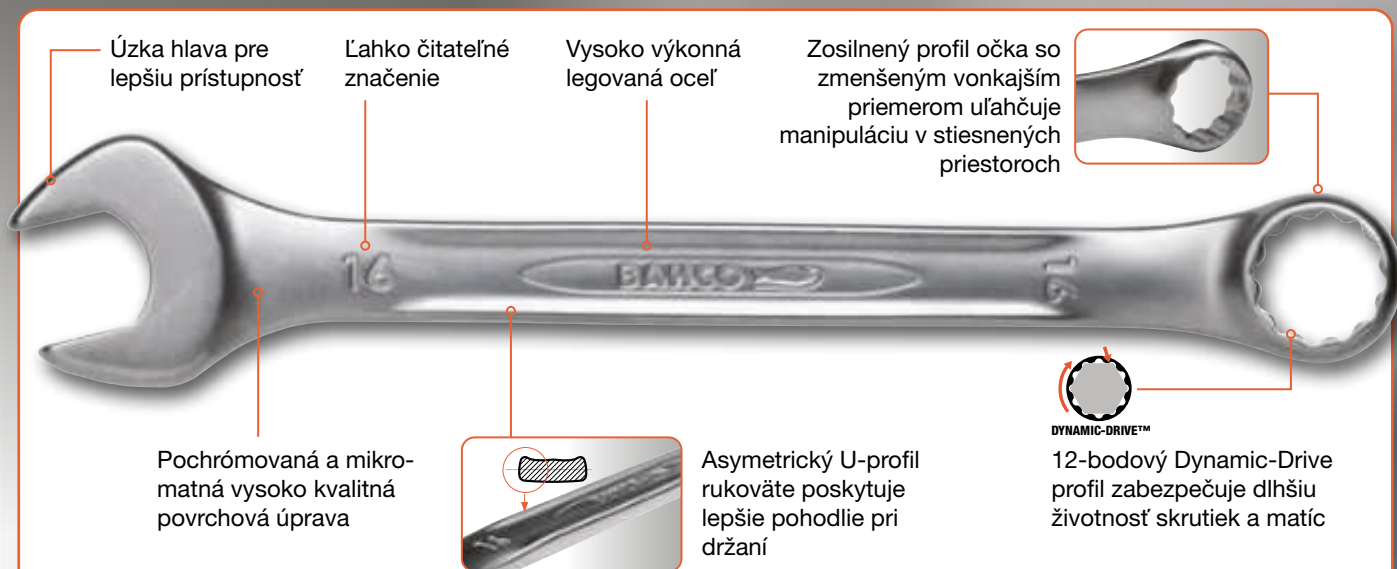

Sada kombinovaných očkoplochých kľúčov

■ ISO 691 / ISO 7738 / ISO 3318 / ISO 1711-1 / DIN 3113

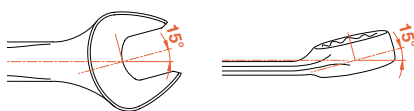

Metrické rozmery



111M/11T

8 9 10 11 12 13 14 15
17 19 22 mm



111M/14T

6 8 9 10 13 14 15 17 19 22
24 27 30 32 mm



111M/26T

6 7 8 9 10 11 12 13 14 15 16 17 18 19
20 21 22 23 24 25 26 27 28 29 30 32 mm



Palcové rozmery



111Z/11T

3/8" 7/16" 1/2" 9/16" 5/8" 11/16"
3/4" 13/16" 7/8" 15/16" 1"



Kombinované račňové kľúče

ISO 1711-1 / DIN 3113



Prepínateľné

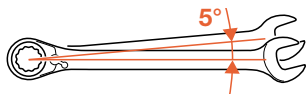
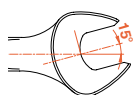

- Vysoko výkonná legovaná oceľ
- Pochrómovaná a mikrokrovná vysoko kvalitná povrchová úprava

BAHCO	mm	mm	g	€
1RM-6	6	128	27	8,40
1RM-7	7	140	35	8,40
1RM-8	8	140	38	8,40
1RM-9	9	150	48	8,90
1RM-10	10	159	59	9,45
1RM-11	11	165	67	9,45
1RM-12	12	172	82	9,95
1RM-13	13	178	95	9,95
1RM-14	14	191	113	10,70
1RM-15	15	200	130	12,65
1RM-16	16	208	158	12,20
1RM-17	17	226	180	13,05
1RM-18	18	237	213	13,35
1RM-19	19	248	233	13,65
1RM-21	21	290	343	24,20
1RM-22	22	290	343	18,50
1RM-24	24	323	503	22,05
1RM-27	27	359	550	36,25
1RM-30	30	393	750	42,55
1RM-32	32	425	900	48,35

Sada kombinovaných račňových kľúčov, metrických

1RM/SH6
8 10 12 13 14 17 mm

6

69,95 €

1RM/SH8
8 10 11 12 13 14 17 19 mm

8

98,10 €

1RM/SH12
8 9 10 11 12 13 14 15 16 17 18 19 mm

12

145,00 €

Palcové rozmery

1RZ/SH8
5/16" 3/8" 7/16" 1/2"
9/16" 5/8" 11/16" 3/4"

8

229,40 €

6M/10C

Sada obojstranných vidlicových kľúčov

ISO 691 / ISO 1085 /
ISO 10102 / ISO 3318

10

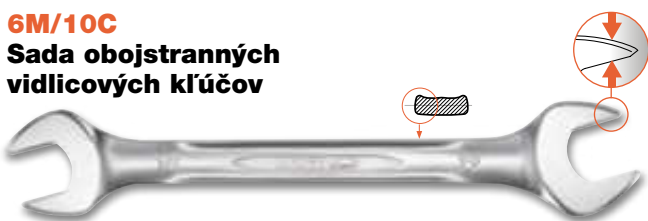

82,85 €



6x7 8x9 10x11 12x13 14x15 16x17 18x19 20x22 24x27 30x32 mm



KLÚČE

10RM/SH6

Sada kombinovaných račňových kľúčov, krátkých

■ ISO 3318 / DIN 3113



72,95 €

8 10 13 14 17 19 mm

1320RM/SH8

Sada obojstranných račňových kľúčov



150,00 €

6x7 8x9 10x11 12x13 14x15
16x17 18x19 22x24 mm

S4RM/3T

Sada obojstranných račňových kľúčov, 4 v 1

3



12 ROZMEROV V 3 KLÚČOCH

8x9x10x11 mm
12x13x14x15 mm
16x17x18x19 mm

39,00 €

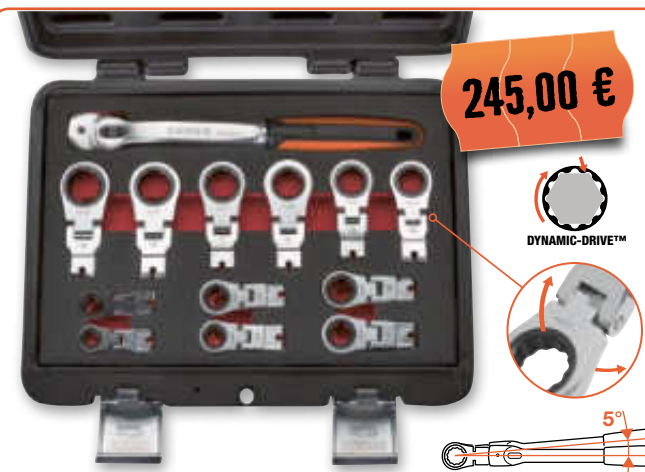

245,00 €

42RM/S12

Sada račňových nastaviteľných očkových kľúčov s kĺbom

12

- Určené pre dosiahnutie do ťažko prístupných oblastí
- Nastaviteľné na 180 a 360°

8 9 10 11 12 13 14
15 16 17 18 19 mm
+ 1 račaňa

Nastaviteľný hákový kľúč



- Kĺbová hlava s hákom pre rôzne priemery límcov, krúžkov a ložísk

BAHCO	mm	mm	g	€
4106-19-50	19-50	158	130	16,20
4106-20-35	20-35	165	185	20,30
4106-32-75	32-75	203	240	20,70
4106-35-60	35-60	210	170	22,30
4106-60-90	60-90	280	360	28,35
4106-90-155	90-155	335	610	36,65
4106-155-230	155-230	460	1200	63,25



PNEUMATICKÉ NÁRADIE

Rázové ťahovák

120 mm



BPC813

1/2"

max. 678 Nm



BPC814

1/2"

max. 624 Nm



BPC815

1/2"

max. 1112 Nm



BPC817

3/4"

max. 2034 Nm



Video návody na použitie a údržbu

BAHCO	1/2"	BAR	mm	l/min	Nm	Max Nm	min-1	dba	mm	kg	€
BPC813	1/2"	6.3	10	113	407	678	10 000	87	120	1.54	155,00
BPC814	1/2"	6.3	10	113	338	624	12 000	87	142	1.24	175,00
BPC815	1/2"	6.3	10	113	786	1112	8 000	88	187	1.91	199,00
BPC817	3/4"	6.2	10	198	1627	2034	5 000	96	220	3.44	399,00

BP814A

Rázový račňový ťahovák

1/2"

max. 244 Nm



299,00 €

- Výkonnejší a rýchlejší ako samotná račňa
- Ideálny pre prácu v zúžených miestach

1/2"	BAR	mm	Nm	Max Nm	min-1	dba	mm	kg
1/2"	6.2	10	195	244	7 000	97	334	1.8

BP700
Mini račňa

1/4"



BP820
Račňa

3/8"



BP821
Račňa

1/2"



BAHCO	BAR	mm	U/min	Nm	min ⁻¹	dba	mm	kg	€	
BP700	1/4"	6.3	10	65	0-30	300	94	133	0.5	99,00
BP820	3/8"	6.3	10	120	0-67	270	80	256	1.2	125,00
BP821	1/2"	6.3	10	120	0-67	150	80	256	1.2	125,00



Excentrická brúska

- Vráťane brúsneho kotúča Velcro®



Brúsenie:

- 5 mm excenter pre hrubé brúsenie
- 2.5 mm excenter pre jemné brúsenie



Dá sa použiť so systémami s centrálnym odsávaním



m/sec²
< 2.5



BAHCO	mm	mm	BAR	mm	U/min	W	min ⁻¹	dba	m/sec ²	mm	kg	€
BP601	152	5	6.3	10	255	224	11 000	80	< 2.50	195	0.8	145,00
BP610	152	2.5	6.3	10	255	224	11 000	80	< 2.50	195	0.8	145,00

Pásová brúska

- Ideálna pre prácu v stiesnených priestoroch
- Mechanizmus rýchlej výmeny pásiky

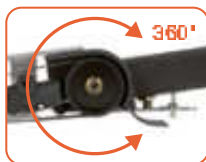

Nastaviteľná rukoväť pre pohodlnú pracovnú polohu

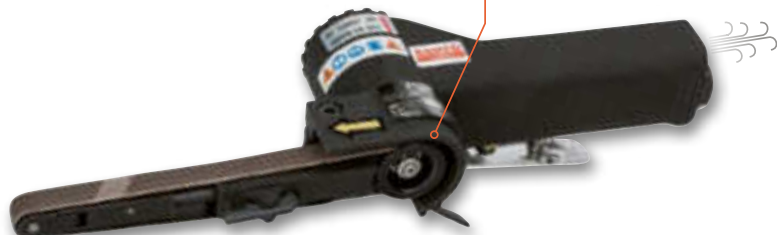

BAHCO	mm	BAR	mm	U/min	min ⁻¹	dba	m/sec ²	mm	kg	€
BP212	10	6.3	10	170	16 000	83	< 2.50	330	0.8	99,00
BP222	20	6.3	10	170	16 000	83	< 2.50	520	0.8	165,00

Náhradné pásy pre pásové brúsky

25



BAHCO	mm	€
BPN21201	10	73,00
BPN22201	20	89,00

PNEUMATICKÉ NÁRADIE

BP127P

Hľový oklepávač s pištoľovou rukoväťou



19 ihiel 3 x 180 mm

199,00 €

BAR	mm	min ⁻¹	dba	m/sec ²	mm	kg
6.3	10	3800	98-109	18.10	330	2.7

BPN010

Čistiaca pištoľ



1 L

- 2 režimy prevádzky: čistenie (mydlo a vzduch) a sušenie (len vzduch)
- Objem nádrčky: 1 liter

137,00 €

BAR	mm	l/min	min ⁻¹	kg
6.2	10	67	6000-7500	0.9

Pneumatická fúkacia pištoľ

- Vložka z mosadze

BAHCO	BAR	mm	l/min	dba	mm	kg	€
BP219	6.3	10	68	<80	240	0.13	9,45
BP219L	6.3	10	340	<80	470	0.15	10,15
BP219XL	6.3	10	100	<80	1050	0.25	16,50

BP219XL
extra dlhá verzia, 1000 mm

BP219L
dlhá verzia, 300 mm

BP219

Pneumatická nitovačka

- Pre nity na všetky materiály až do 6,4 mm: hliník, oceľ, nehrdzavejúca oceľ a konštrukčné nity, vrátane slepých nitov



BP125A



6

BP277K



4



BAHCO	mm	BAR	mm	kg	mm	mm	kg	€
BP125A	2.4-3.2-4.0-4.8-5.6-6.4	6.3	10	1600	19	260	2	347,00
BP277K	2.4-3.2-4.0-4.8	6.3	10	880	14	230	1.5	119,00

BP824

Pneumatická píla s vratným pohybom s bezpečnostným vypínačom

189,00 €



- Pílové listy pre rovné, zakrivené a priame rezy



BAR	mm	l/min	min ⁻¹	dba	m/sec ²	mm	kg
6.3	10	160	10000	85	3.70	285	0.68

BPH1310A

Špirálová vzduchová hadica



- Polyuretánová hadica so závitovým pripojením na oboch koncoch

mm	m
1/2"-1/2"	10

56,75 €

Karosárske pílové listy Sandflex® z Bimetalu

10

- Pre pneumatické a elektrické píly značiek Shinano, Chicago-Pneumatic a pod.
- Bimetalové pílové listy Sandflex® pre presný rez a dlhú životnosť



BAHCO			mm	€
3845-18-10P	10	18	91.5	8,10
3845-24-10P	10	24	91.5	8,10
3845-32-10P	10	32	90	8,10

Otočné pneumatické konektory 1/4"

- Pre väčšiu bezpečnosť, pohodlie a efektívnosť bez skrútených hadíc



BPSJ



12,70 €

BPSJL so zámkom otáčania

- Uvoľnenie rotačnej funkcie prívodom stlačeného vzduchu, pevné bez tlaku



19,50 €

BP255T

Vzduchový filter s regulátorom 1/2" a maznica s vypúšťaním čistého suchého vzduchu, typ T

119,00 €



- Na bezproblémovú údržbu pneumatického náradia
- Prídavné vypúšťanie čistého suchého vzduchu za regulátorom vzduchového filtra a pred maznicou, pre ofukovacie pištole alebo lakovacie pištole

BPN251

Sekundárna maznica stlačeného vzduchu

- 1/4"



7,00 €

BP500

Magnetický držiak



45,00 €

AKUMULÁTOROVÉ NÁRADIE



Kovové puzdro uloženia pre dlhšiu životnosť a výkon



Vš
v
a nabíjačkou

Nový sortiment pre náročných mechanikov

BCL31IS1K1 Aku Mini rázový skrutkovač - sada

1/4"

12V

max. 105 Nm

155 mm



Rýchlopínacie skľučovadlo

0.93 kg

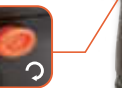

IP20



Video BCL31IS1



159,00 €

- Kovové puzdro uloženia pre dlhšiu životnosť a výkon
- Nízke vibrácie vďaka dvojzložkovej rukoväti



1/4"	V	Max Nm	min-1	dba	m/sec ²	mm	kg
1/4"	12	105	0-2400	101.1	8.85	155x50x191	0.93

BCL33IW1K1 Aku rázový uťahovák - sada

1/2"

18V

2 rozsahy otáčok

110 Nm (550 ot./min.) + 590 Nm (1650 ot./min.)



IP20

369,00 €

- Kovové puzdro uloženia pre dlhšiu životnosť a výkon
- Indikátor stavu akumulátora počas prevádzky



1/2"	V	Max Nm	min-1	dba	m/sec ²	mm	kg
1/2"	18	105 / 590	0-550 / 0-1650	99.2	6.65	260x70x258	3.11

BCL33IW2K1

Aku rázový uťahovák - sada



1/2"

18V

max. 1000 Nm

HD

IP20

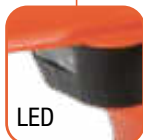

Indikátor stavu akumulátora



- Vysoká účinnosť, vynikajúci výkon
- Kovové puzdro uloženia pre dlhšiu životnosť a výkon

	V						
1/2"	18	1000	0-1700	100.6	6.37	240x65x360	3.1

BEZUHLÍKOVÝ MOTOR



- ✓ vysoký krútiaci moment
- ✓ vyššia frekvencia úderov
- ✓ jednoduchá údržba
- ✓ dlhšia životnosť

399,00 €



BCL33CIW2D

Aku Kombo sada

Vrtačka a rázový skrutkovač

439,00 €

18V

2x



1/2"-13 mm

2 rozsahy otáčok

0-370 ot./min. + 0-1570 ot./min.



10 rôznych nastavení krútiaceho momentu
1 nastavenie vrtania



max. 1000 Nm

HD

IP20

- Nízke vibrácie vďaka dvojzložkovej rukoväti
- Indikátor stavu akumulátora počas prevádzky

	V					
13	18	32	0-370 / 0-1570	83.5	180x60x290	1.35

BEZUHLÍKOVÝ MOTOR



- ✓ vysoký krútiaci moment
- ✓ vyššia frekvencia úderov
- ✓ jednoduchá údržba
- ✓ dlhšia životnosť



18 V 5 Ah
Lítium-
iónový
akumulátor



18 V 2.3 A
Nabíjačka

	V						
1/2"	18	1000	0-1700	100.6	6.37	240x65x360	3.1

AKUMULÁTOROVÉ NÁRADIE

BCL33AP1K1

Aku uhlová brúska - sada

Ø 5"/127 mm Velcro®

18V

319,00 €



IP20



2.52

Nastaviteľná rýchlosť:

- 1100
- 1450
- 2300
- 3050
- 3500

ot./min.

Indikátor stavu akumulátora



Pravo-/ľavostranná prídavná rukoväť pre lepšie ovládanie náradia

Aretačné tlačidlo s bezpečnostným vypínačom

- Dodáva sa so špongiou a vlneným návlekom na čistenie a leštenie
- S bezpečnostným vypínačom
- Aretačné tlačidlo vypínača pre vyšší komfort práce
- Nízke vibrácie vďaka dvojzložkovej rukoväti



x2

18 V 5 Ah
Lítium-
iónový
akumulátor



x1

18 V 2.3 A
Nabíjačka

Ø mm	V	Ø mm	mm	min ⁻¹	dba	m/sec ²	mm	kg
127	18	4.7	5/16" 24UNF	1100-3500	82.5	2.52	376x153	1.82

BCL31R1

Aku račňový kľúč so štvorhranným unášačom

1/4"

12V



LED



0.77
kg

- Jednoduchá zmena na 3/8" alebo 1/2" pomocou plochých adaptérov 7767 a 8167
- Pre lepší a rýchlejší prístup a finálne ručné doťahovanie v automobilovom priemysle, údržbe a opravách.

Vystužené puzdro pre dlhú životnosť, kompaktné a ľahké

Dodáva sa bez akumulátora a nabíjačky

Odporúčaný 12 V akumulátor: 2 Ah, Kód výrobku BCL31B1

Odporúčaná nabíjačka: Kód výrobku BCL31C1

109,00 €



9.47

1/4"	V	Max Nm	dba	m/sec ²	mm	kg
1/4"	12	57	84.8	9.47	60x289	0.77

BCL32G1K1
Aku mazacia
pištoľ - sada
14.4 V

≥ 400 g

414 bar

70g / min.

239,00 €

 ← 750 →
 mm

2 Ah

x2



x1

V	PSI / BAR	g/min.	dba	m/sec ²	mm	kg
14.4	6000-414	70	78.6	0.39	200x75x485	3.4

Abrazívne vysoko výkonné rezné kotúče

■ Certifikované v súlade OSA podľa EN12413



3912-125-T41-IM 3911-125-T41-IM 3911-150-T41-I

BAHCO	Aplikácia/ Materiál	∅ mm	∅ mm	mm	Kvalita	BAL.	€
3912-125-T41-IM	Nerez a kov	125	22,23	1	4★	50	0,90*
3911-125-T41-IM	Nerez a kov	125	22,23	1,6	5★	50	0,90*
3911-150-T41-I	Nerez	150	22,23	1	5★	50	1,45*

■ Neobsahuje železo, síru ani chloridy

Lamelové kotúče

■ Certifikované v súlade OSA podľa EN12413



3926-125IM-C60 3926-125IM-C80 3926-125IM-C120

BAHCO	Aplikácia/ Materiál	∅ mm	∅ mm	Kvalita	BAL.	€
3926-125IM-C60	Nerez a kov	125	22,23	5★	20	3,30*
3926-125IM-C80	Nerez a kov	125	22,23	5★	20	3,30*
3926-125IM-C120	Nerez a kov	125	22,23	5★	20	3,30*

■ Neobsahuje železo, síru ani chloridy

Lamelové kotúče

■ Certifikované v súlade OSA podľa EN12413



3927-125IM-P60 3927-125IM-P80 3927-125IM-P120

BAHCO	Aplikácia/ Materiál	∅ mm	∅ mm	Kvalita	BAL.	€
3927-125IM-P60	Nerez a kov	125	22,23	4★	20	2,75*
3927-125IM-P80	Nerez a kov	125	22,23	4★	20	2,75*
3927-125IM-P120	Nerez a kov	125	22,23	4★	20	2,75*

■ Lhké, pružné a tiché vďaka viacvrstvovému uloženiu brúsnych lamiel

■ Neobsahuje železo, síru ani chloridy

Vysoko výkonné rezné kotúče

■ Certifikované v súlade OSA podľa EN12413



3921-125-T27-IM

3921-150-T27-IM

BAHCO	Aplikácia/ Materiál	∅ mm	∅ mm	mm	Kvalita	BAL.	€
3921-125-T27-IM	Nerez a kov	125	22,23	6.4	5★	25	1,65*
3921-150-T27-IM	Nerez a kov	150	22,23	6.4	5★	25	2,40*

■ Neobsahuje železo, síru ani chloridy

Dodáva sa iba celé balenie

*Cena za kus

MOMENTOVÉ NÁRADIE

74WR-

Mechanický momentový kľúč, nastaviteľný

- Odolný mechanizmus zvládne viac než 100 000 cyklov s presnosťou merania $\pm 3\%$
- Pevná račňová hlava
- Presnosť uťahovacieho momentu $\pm 3\%$, podľa normy ISO 6789-1:2017



Odolný voči:
benzín, olej,

hydraulické kvapaliny



Lahko čitateľná
dvojíta stupnica



Klikací systém vydáva
hmatový a zvukový signál



Označenie
stredu rukoväte
pre optimálne
uchopenie



Značenie
kalibrácie

BAHCO	Nm	mm	mm	g	€
74WR-15	3–15	1/4"	221	300	109,00
74WR-25	5–25	1/4"	221	300	109,00

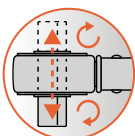

- Priečodný štvorhran
na zmenu smeru otáčania



Pohodlný na
dotyk príjemný
povrch rukoväte



Odolný voči:
benzín, olej,
hydraulické kvapaliny

Tlačidlo na nastavenie krútiaceho momentu, zreteľne viditeľné pri uvoľnení

BAHCO	Nm	ft.lb	mm	mm	g	€
74WR-50	10–50	7.5–37.5	3/8"	335	700	109,00
74WR-100	20–100	15–75	1/2"	387	900	112,00
74WR-200	40–200	30–150	1/2"	470	1100	115,00
74WR-300	60–300	45–220	1/2"	593	1400	125,00
74WR-340	60–340	45–250	1/2"	685	1500	125,00
74WR-400	80–400	60–300	3/4"	686	1900	199,00

7455-

Mechanický momentový kľúč, s pevnou obojsmernou račňovou hlavou a kovovou rukoväťou

- Presnosť uťahovacieho momentu ±4 %
- Dodáva sa s certifikátom podľa normy DIN EN ISO 6789
- Vyrobený v USA

Môže sa používať v oboch smeroch otáčania



Klikací systém vydáva hmatový a zvukový signál po dosiahnutí krútiaceho momentu



Robustný, celokovový odolný kľúč



Nekízavá, vrúbkovaná kovová rukoväť, odolná voči nárazom a všetkým bežným chemikáliám



BAHCO	Nm	ft.lb	□	←mm→	g	€
7455-5	1-5	11-42	1/4"	258	0.386	109,00
7455-15	3-15	31-128	1/4"	258	0.409	109,00
7455-20	4-20	40-173	1/4"	258	0.386	109,00
7455-25	5-25	49-217	1/4"	286	0.410	109,00
7455-60	10-60	9.2-42.2	3/8"	393	1.135	109,00
7455-100	20-100	16.6-71.9	3/8"	400	1.135	112,00
7455-200	40-200	37-140	1/2"	474	1.430	115,00
7455-300	60-300	52-314	1/2"	483	1.440	125,00
7455-340	60-340	52-243	1/2"	613	1.680	125,00
7455-500	100-500	83-359.6	3/4"	870	4.370	359,00
7455-800	150-800	129-572	3/4"	1047	5.310	499,00
7455-1000	200-1000	184-701	1"	1055	6.350	755,00



BAHCO	Nm	ft.lb	□	←mm→	g	€
7455-1500	300-1500	258-1069	1"	1780	11.395	1.099,00



Môže sa používať v oboch smeroch otáčania



S kovovou dvojdielnou rukoväťou



BAHCO	Nm	ft.lb	□	←mm→	g	€
7455-2500	500-2500	406-1807	1"	2720	24.120	1.999,00



S kovovou trojdielnou rukoväťou

MOMENTOVÉ NÁRADIE

TAW- Elektronický momentový kľúč s nastavovaním uhla uťahovania

- Programovateľné automatické vypínanie
- Uchovanie údajov a nastavení počas výmeny batérie



- Pevná račňová hlava s kĺbom, 40 zubov

- LED diódy na oboch stranách



- Bol dosiahnutý prah predbežného varovania
- V cieľovom rozsahu
- Mimo toleranciu



- Nm, Kg.cm., dNm, Lbf.ft., Lbf.in.



- Vibrovanie rukoväte

- 50 meraní
- 10 prednastavení

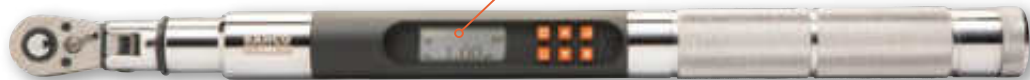
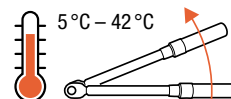

- Režimy merania:
 - Krútiaci moment
 - Uhol
 - Krútiaci moment a potom uhol
 - Prednastavené hodnoty

BAHCO	Nm	mm	mm	g	€
TAW38135	7-135	3/8"	475	1.270	499,00
TAW12340	17-340	1/2"	670	1.910	569,00
TAW34800	40-800	3/4"	1.235	4.850	999,00

TAW1430M Elektronický mikro kľúč na meranie momentu a uhla

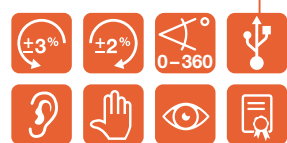

- Režimy merania:
 - Krútiaci moment
 - Uhol
 - Krútiaci moment a potom uhol
 - Prednastavené hodnoty
 - Pracovný režim

- 50 meraní
- 10 prednastavení

- Obzvlášť ľahký a kompaktný



BAHCO	Nm	mm	mm	g	€
TAW1430M	1.5-30	1/4"	292	405	529,00

TSS600 Nastaviteľný momentový skrutkovač so stupnicou v Nm a in.lb.

- Meranie krútiaceho momentu iba pri uťahovaní doprava
- Presnosť ±6 % pri uťahovaní doprava
- Testované podľa normy DIN EN ISO 6789



Ochrana proti pretočeniu spojku zabraňuje prekročeniu nastavenej hodnoty krútiaceho momentu pri uťahovaní doprava

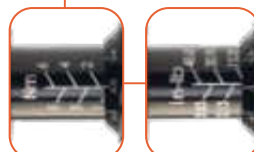

Ľahko čitateľná dvojita stupnica v Nm a in.lb.

Pogumovaná rukoväť s otvorom 1/4" pre upevnenie T-rukoväte

BAHCO	Nm	mm	mm	g	€
TSS600	1-6	1/4"	195	340	125,00

TESTERY MOMENTU

Multifunkčné testery krútiaceho momentu pre momentové kľúče

- Možnosť montáže v horizontálnej i vertikálnej polohe
- Vrátane nabíjačky 110/220V
- Vrátane prehlásenia výrobcu o zhode
- 2014/30 / EC, ISO 6789

Presnosť $\pm 1\%$

Tri pracovné režimy: vrchol, klik a sledovanie

Až 10 nastavení cieľového momentu s príslušnými toleranciami

TEA350: s 1/2" vnútorným štvorhranom
TEA1100: s 27 mm vonkajším šesťhranom

Prenos dát cez micro USB do PC

Intuitívne ovládanie pomocou 4 tlačidiel

IP40



Napájanie cez micro USB. Voliteľne tiež cez USB napájací zdroj, USB výstup z PC alebo USB pripojenie vo vozidle.



Dodáva sa v pevnom plastovom kufri s penovou vložkou



BAHCO	Nm	□	●	g	€
TEA065	3-65	3/8"	—	2.600	899,00
TEA350	10-350	1/2"	—	2.700	799,00
TEA1100	50-1100	—	27 mm	3.500	1.099,00
TEA2100	200-2100	—	27 mm	3.500	1.469,00



Optický (podsvietený LCD displej) a akustický signál



ŠPECIÁLNE NÁRADIE NA KOLESÁ A PREVODOVKY

4590SHS5

Sada vnútorných a vonkajších vyťahovačov



- Na vyťahovanie poistných krúžkov, guľkových ložísk, atď.
- Automatické vystredovanie

143,00 €

Obsah:

4590SHS5-01	T rukoväť s posuvným úderovým závažím	
4590SHS5-02	Adaptér pre vonkajšie vyťahovanie	
4590SHS5-03	Pridržiavacie čeluste a adaptér pre vnútorné vyťahovanie	Ø 30 – 80 mm
4590SHS5-04	Pridržiavacie čeluste a adaptér pre vnútorné vyťahovanie	Ø 15 – 30 mm
4590SHS5-05	Pridržiavacie čeluste a adaptér pre vonkajšie vyťahovanie	Ø 15 – 80 mm

BWB14

Sada náradia na ložiská kolies



143,00 €

- Vhodné pre väčšinu európskych vozidiel

Obsah:

9	Adaptér	Ø 55,5 – 84 mm
1	Tesniaci kryt	76 mm
2	Ochranný plášť	86,91 mm
1	Sťahovák	38 mm
1	Stredový hriadeľ, skrutka, čap	

BS6

Vidlicový sťahovák



- Pre rýchlu demontáž tyče riadenia
- Klinový vidlicový sťahovák tvaru U

BAHCO	mm	mm	€
BS618	18	400	16,70
BS623	23	400	16,70

BWTVCTT355

Momentový skrutkovač pre tesniaci ventil

- Na zaskrutkovanie kovových tesniacich ventilov
- Zabraňuje pretočeniu



12,95 €



**38-
Montážna páka
na pneumatiky**

■ Oceľ Vanadium-Extra

BAHCO	mm	€
38-8	200	10,65
38-12	300	12,20
38-16	400	14,90
38-20	500	20,40
38-24	600	28,10



**38A-
Montážna páka
na pneumatiky**

■ Vysokovýkonná legovaná oceľ

BAHCO	mm	€
38A-12	300	6,65
38A-15	380	7,90
38A-21	530	15,25
38A-26	650	17,30



**38C-26
Montážna páka
na pneumatiky**

BAHCO	mm	€
38C-26	650	19,35



**39-24
Montážna páka
na pneumatiky
nákladných
vozidiel**

BAHCO	mm	€
39-24	600	22,45

**2484/S4
Sada páčidiel**

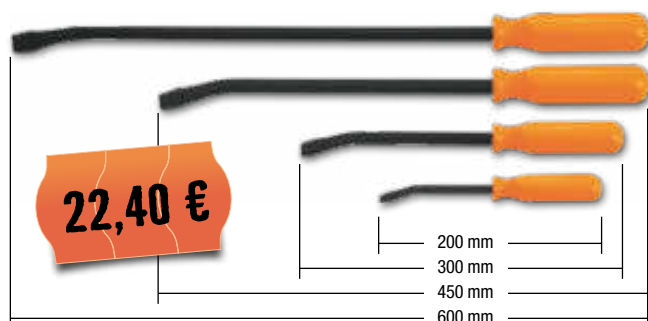

**BT10P-
Nastaviteľné páčidlá so západkou**



BAHCO	mm	€
BT10P325	250	20,40
BT10P330	300	22,40
BT10P338	380	25,45

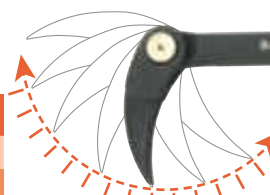

Nastaviteľné do 14 polôh

**BT10P3
Sada
nastaviteľných
páčidiel so
západkou**



88,45 €



250, 300, 380 mm

**BPBL
Páčidlá, dlhé**

■ Rukoväť s protišmykovou úpravou

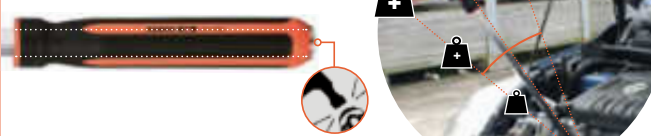

BPBL00900 ∠ 0°

BPBL30900 ∠ 30°

BPBL70600 ∠ 70°

BPBL90600 ∠ 90°

BAHCO	mm	∠	g	€
BPBL00900	930	0°	1980	43,90
BPBL30900	938	30°	1980	43,90
BPBL70600	610	70°	1390	43,90
BPBL90600	624	90°	1530	43,90

ŠPECIÁLNE NÁRADIE NA KOLESÁ A PREVODOVKY

BWSS12P3

Sada rázových nástrčných klúčov



1/2"

- Plastové ochranné puzdro



20,35 €



17 mm

19 mm

21 mm

BWSS12P5

Sada rázových nástrčných klúčov



1/2"

- Plastové ochranné puzdro



43,90 €



17 mm

19 mm

21 mm

22 mm

24 mm

BWSS12P3L

Sada rázových nástrčných klúčov



1/2"

- Extra dlhé prevedenie
- Plastové ochranné puzdro



61,25 €



17 mm

19 mm

21 mm

BWSMB15

Rázový nástrčný klúč

1/2"

- Plastové ochranné puzdro
- Smart, Citroën, etc.

15 mm

10,10 €



85 mm



BWSMB17

Rázový nástrčný klúč

1/2"

- Plastové ochranné puzdro



17 mm

10,10 €



85 mm

- Maybach, Mercedes C (W204), CL (W216), GLK (W204), E (W207, W211, W212), M-GLÉ(W166), ML (W164, W166), S (W221, W222), SLK (W172)

BWSHK21

Rázový nástrčný klúč

1/2"

- Plastové ochranné puzdro
- Hyundai, KIA



21 mm

10,10 €



85 mm

BT15P5

Sada rázových nástrčných klúčov a bitov



1/2"



40,80 €



○ 24 30 32 mm
● 14 17 mm

- Na montáž a demontáž nábojov kolies a náprav, najmä vozidiel skupiny VAG



BWTB12P Torzné tyče

1/2"

- Na uťahovanie matíc kolies rázovým uťahovačom bez prekročenia odporúčaného uťahovacieho momentu
- Farebné označenie pre jednoduchú identifikáciu momentu príslušnej torznej tyče



BAHCO	Nm / ft-lbs	Farba	€
BWTB12P90	90 Nm / 65 ft-lbs	zelená	16,60
BWTB12P100	100 Nm / 75 ft-lbs	čierna	16,60
BWTB12P110	110 Nm / 80 ft-lbs	zlatá	16,60
BWTB12P120	120 Nm / 90 ft-lbs	červená	16,60
BWTB12P135	135 Nm / 100 ft-lbs	modrá	16,60
BWTB12P150	150 Nm / 110 ft-lbs	oranžová	16,60
BWTB12P160	160 Nm / 120 ft-lbs	šedá	16,60
BWTB12P175	175 Nm / 130 ft-lbs	fialová	16,60
BWTB12P190	190 Nm / 140 ft-lbs	biela	16,60
BWTB12P200	200 Nm / 150 ft-lbs	svetlo zelená	16,60

BWTB12P5 Sada torzných tyčí

1/2"



BAHCO	Nm / ft-lbs
BWTB12P90	90 Nm / 65 ft-lbs
BWTB12P100	100 Nm / 75 ft-lbs
BWTB12P110	110 Nm / 80 ft-lbs
BWTB12P120	120 Nm / 90 ft-lbs
BWTB12P135	135 Nm / 100 ft-lbs



92,00 €



29-B Kľúč na kolesá

1/2"

17, 19, 21 mm

12,50 €

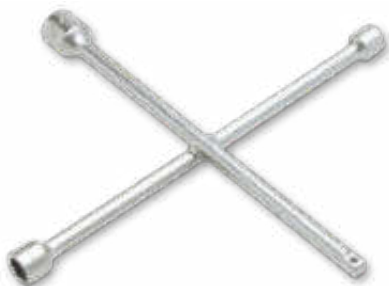

BWBB Vrecko na skrutky kolies

300 x 180 mm

3,95 €



BWTPG1 Merač tlaku vzduchu v pneumatikách

Materiál: hliník

29,05 €



Rýchle a jednoduché odčítavanie tlaku
Dve stupnice tlaku:
max. 10 bar / 150 psi

Dve vložky pre meranie tlaku
na rôznych typoch ventilov

BWC1 Klíny pod kolesá

- Robustný plast s mriežkovým profilom
- Certifikované ROHS

10,10 €



75 mm

110 mm

ŠPECIÁLNE NÁRADIE NA KOLESÁ A PREVODOVKY

Sada špeciálnych nástrčných hlavíc so špirálovým profilom



- Na uvoľňovanie poškodených matic a skrutiek a najmä na poistné matice kolies
- Špeciálny špirálový profil umožňuje zahryznutie kľúča do matice/skrutky a tým aj jej bezpečné uvoľnenie
- Nevhodné pre rázové uťahovanie



BWTSP6

Sada špeciálnych nástrčných hlavíc so špirálovým profilom



1/2"

■ S priebojníkom



46,95 €

1/2" 17, 19, 21, 22, 24 mm

1 priebojník

BWTSP7

Sada špeciálnych nástrčných hlavíc so špirálovým profilom



1/2" & 3/4"

■ S priebojníkom



115,00 €

1/2" 22, 24, 27, 32 mm

3/4" 36, 41 mm

1 priebojník

BWTSP3L

Sada špeciálnych nástrčných hlavíc so špirálovým profilom, dlhých



1/2"

81,70 €



1/2" 17, 19, 21 mm

BWTSP16

Sada špeciálnych nástrčných hlavíc so špirálovým profilom



3/8" & 1/2"

■ S priebojníkom

112,00 €

3/8" 8, 10, 11, 12, 13, 14, 16, 17, 18, 19 mm

1/2" 21, 22, 24, 27 mm

1/2" 3/8" 1 priebojník



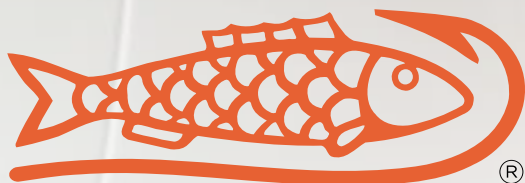

BAHCO

OFICIÁLNY **PARTNER** ÚSPEŠNÝCH



Mechanici pretekárskeho tímu Signatech
Alpine Matmut Racing Team



Bahco Heroes
youtu.be/lng4UK_CGI4



BAHCO



ŠPECIÁLNE NÁRADIE NA ZÁVESNÉ SYSTEMY KOLIES



286,00 €



BS15 Na stláčanie pružín McPherson

- Na bezpečnú motnáz a demontáž pružín McPherson
- Univerzálne použitie, pokrýva 90% značiek vozidiel
- Šesťhrannú 24 mm hlavu možno ovládať ručne alebo pneumatickým náradím
- Chrániče pružín v čelistiach

BS15125	BS15125C		BS1540	BS1550
x2	x2	BS-115 mm		
BS15180	BS15180C	110-150 mm		
x2	x2			
BS15212	BS15212C	140-180 mm		
x2	x2			

BS25

Univerzálna páka na rameno nápravy

174,00 €



- Vďaka flexibilnej retiazke je možné bez väčšej námahy bezpečne stlačiť priečne ramená rôznych typov
- Špeciálna páka na profesionálnu a bezpečnú montáž a demontáž častí nápravy



BS30PG
Pneumatický kompresor
na stláčanie pružín
s dvojitým valcom

1.399,00 €

- Pracovný tlak: 5-10 atm
- Kompresný zdvih: 300 mm
- Šírka otvoru: 450 mm



So štyrmi háčikmi, ktoré je možné nastaviť nezávisle na sebe



S ochrannou mriežkou



S oceleovým lankom pre zaistenie a bezpečnosť

BS30AC1
Mobilný podstavec

- Voliteľný mobilný podstavec pre BS30

199,00 €



34 cm



39

220,00 €



BS1000
Servisná sada náradia na tlmiče nárazov

- Na pridržanie piestnej tyče pri demontáži a inštalácii tlmiča
- Na presné dotiahnutie krútiaceho momentu piestnych tyčí tlmiča
- Chrom-vanádiové bity v robustnom plastovom kufríku

BS100001	19			14	Honda, Nissan
BS100002	19			16	VW - Audi, Seat, Fiat
BS100003	19			17	Ford, VW - Audi, Seat, Fiat
BS100004	22			18	Ford, VW - Audi, Seat, Fiat, Rover, Opel, Peugeot, Renault, Japanese Cars
BS100005	22			19	VW - Audi, Seat, Citroen, Fiat, Opel, Peugeot, Toyota
BS100006	22			21	Mercedes Benz (W203), Chrysler, VW - Audi, Japanese Cars, Ford
BS100007	22			22	VW - Audi, Seat, Citroen, Fiat, Opel, Peugeot, Renault, BMW
BS100008	22			24	Volvo
BS100009	22			27	VW - Audi, Citroen, Peugeot
BS100010	10			3	Mercedes Benz, Opel, Renault
BS100011	10			3.5	Chrysler, Ford, Citroen, Peugeot
BS100012	10			4	Citroen, Peugeot
BS100013	10			4	Nissan
BS100014	10			5.2	VW - Audi, Nissan
BS100015	10			6	VW - Audi, Renault
BS100016	10			6.3	Nissan
BS100017	10			7	VW - Audi, Seat, Fiat
BS100018	10			8	Seat, Fiat
BS100019	10			9	Japanese Cars
BS100020	10			10	Seat, Fiat, Volvo
BS100021	10			12	Seat, Fiat
BS100022	10			5	Honda
BS100023	10			6	Seat, Fiat, Citroen, Peugeot, Ford, Opel, BMW, Renault, Japanese Cars
BS100024	10			7	VW - Audi, Seat, Fiat, Citroen, Peugeot, Renault, Mercedes Benz (W203)
BS100025	10			8	Mercedes Benz
BS100026	10			12	Opel, Vauxhall
BS100027	10			T60	Ford
BS100028	10			T50	Ford, Nissan
BS100029	10			D5	Nissan
BS100030	10			D10	Nissan, Ford
BS100031	10			8	Mercedes Benz
BS100032	10			9	Opel - Vauxhall, Chrysler
BS100033	10			10	Chrysler, Ford & Bit Holder
BS100034	10			11	Japanese Cars
BS100035	10.5X3.5 mm			22	VW Golf Rear Axle
BS100036	12.5X3.5 mm			22	Polo Front Axle
BS100037	14.5X5 mm			22	Polo, Golf, Passat, Audi B0
BS100038	14.5X3 mm			22	Audi Maestro
BS100039	14X2.5 mm			22	Mercedes Benz W203 (C-Class) W-209 (CLK)

ŠPECIÁLNE NÁRADIE

BBR100 Tester brzdovej kvapaliny



36,75 €

- Rýchle meranie obsahu vody v brzdovej kvapaline
- Všetky brzdové kvapaliny na báze glykolu
- (DOT3, DOT4, DOT 5.1)
- Rýchla kontrola (1 s) obsahu vlhkosti
 - < 1 %: Dobrá
 - > 2 %: Uspokojivá
 - > 3 %: Musí sa vymeniť



BBR204 Kliešte na pružinu lanka ručnej brzdy

- Na demontáž a montáž lanka ručnej brzdy na brzdových čelustiach bubnových bŕzd
- Rýchla a bezpečná práca, ľahká manipulácia



20,00 €

- Vhodné pre rôzne vozidlá, napr. od VW, BMW, skupiny PSA, od Nissanu, Renaultu atď.

BBR110 Tester hustoty brzdovej kvapaliny

- Indukuje vizuálne na stupnici s 10 LED diódami množstvo absorbovanej vlhkosti meraním vodivosti brzdovej kvapaliny
- Kapacita:
 - DOT 3
 - DOT 4
 - DOT 5
 - DOT 5.1
- CAN zbernica spôsobilá

68,40 €



BBR350 Na odvzdušnenie brzdovej kvapaliny



Univerzálny gumený odvzdušňovací ventil pre všetky brzdové systémy

- Vákuový systém
- Dá sa použiť aj pre iné aplikácie, ako sú prevodovky, spojky, motory

143,00 €

BBR50- Kľúč na odvzdušnenie bŕzd

3/8"



- Uvoľňuje tiež mimoriadne pevné odvzdušňovacie skrutky na brzdovom strmeni
- Patentovaný dizajn

BAHCO	Ø	€
BBR501011	10 / 11 mm	49,00
BBR50121314	12 / 13 / 14 mm	49,00



NA BRZDY

BBR201P6

Sada rázových nástrčných klúčov s XZN bitmi



1/2"

XZN



M14 M16 M18 |← 40 mm →|

M14 M16 M18 |← 78 mm →|



39,75 €

BBR203P9

Sada rázových nástrčných klúčov s TORX® bitmi, dlhých



1/2"

TORX®



T20 T25 T27 T30
T40 T45 T50 T55 T60 |← 78 mm →|



51,05 €

BBR202P4

Sada nástrčných klúčov s vnútorným a vonkajším 5-hranom na ručnú brzdú



1/2"

+



- Pre nastavenie a inštaláciu väčšiny ručných brzdových systémov Girling a Bendix

10 14 19 mm

M10



20,35 €

BBR300P50

Sada náradie pre brzdový strmeň



199,00 €

- Určené na vysúvanie a zatlačanie brzdových piestikov a na servis brzdových doštičiek
- Vhodný pre najbežnejšie európske a japonské vozidlá
- S vretenami s pravým a ľavým závitom

BBR320

Sada pneumatického náradia na sťahovanie brzdových strmeňov



3/8"



51,15 €

- Na vyťahovanie a otáčanie brzdových piestikov
- Rýchle a bezpečné používanie
- Pracuje v oboch smeroch: doľava aj doprava



782-U

Drôtená kefa

Drevená rukoväť

2,95 €

Štyri rady štetín z nehrdzavejúcej ocele

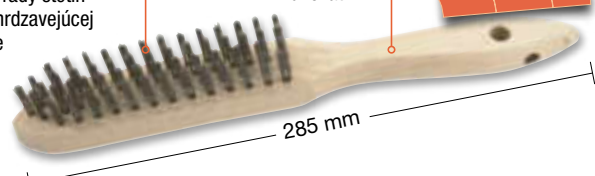

- Na odstránenie nečistôt, hrdze, farieb, lakov atď.

ŠPECIÁLNE NÁRADIE NA MOTORY

Nástrčný kľúč na žeraviace sviečky

- S mosadzným nákrúžkom a magnetom na zaistenie sviečky



DYNAMIC-DRIVE™

7406ZZ

3/8"



BAHCO					€
7406ZZ-16	3/8"	16 mm	5/8"	65	12,15
7406ZZ-21	3/8"	21 mm	13/16"	65	12,15

7805ZZ

1/2"



BAHCO					€
7805ZZ-16	1/2"	16 mm	5/8"	69	12,15
7805ZZ-21	1/2"	21 mm	13/16"	73	12,15

BE1SP14L

Nástrčný kľúč na žeraviace sviečky, dlhý

3/8"



DYNAMIC-DRIVE™

- Vnútroňný záchytný systém na držanie žeraviacej sviečky
- 14 mm, 12-hranný profil umožňuje inštaláciu 6- a 12-hranných žeraviacich sviečok
- Dlhá verzia špeciálne navrhnutá pre motory s hĺbkou inštaláciou sviečok



BAHCO					€
BE1SP14L	3/8"	14 mm	9/16"	252	25,00

BE1T

Kardanový kľúč na žeraviace sviečky

- S gumovým pridržiavacím systémom



BAHCO			€
BE1T14	14 mm	310	19,30
BE1T16	16 mm	450	20,35
BE1T21	21 mm	450	24,90

BE1P

Kliešte na žeraviace sviečky

- Na sťahovanie krytiel žeraviacich sviečok bez poškodenia káblov



BE1GP5

Sada nástrčných kľúčov na žeraviace sviečky

5

1/4"



DYNAMIC-DRIVE™

- Vhodné pre všetky bežné žeraviace sviečky



S poistným krúžkom a guľôčkou proti vypadnutiu



8, 9, 10, 12, 14 mm

52

Drôtená kefa na žeraviace sviečky

2,30 €

- Jemné štetiny z mosadzného drôtu

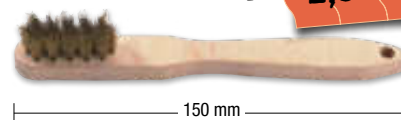

783

Oceľová kefa na brzdomé kotúče a bubny

7,65 €

- S plastovou rukoväťou



782-U

Drôtená kefa

2,95 €

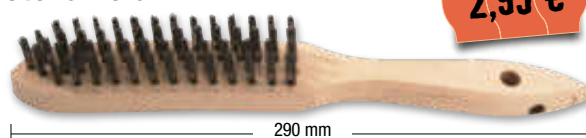

BE1310P4
Sada nástrčných klúčov
na vstrekovacie dýzy

4

1/2"

59,00 €



- S vnútorným šesťhanom a okienkom
- Pre dýzy: Bosch, Siemens, PSA 2.0HDI [110/135 PS]

25, 27, 29, 30 mm

BE5500
Sada špeciálnych nástrčných
klúčov, s drážkami

6

- Na montáž horných a bočných káblových snímačov teploty, tepelných spínačov a iných komponentov

30,55 €

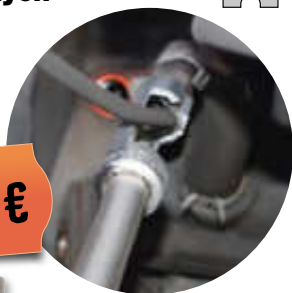

3/8" 10, 11, 12, 14 mm

1/2" 17, 19 mm

BE5049T
Sada bitov

10 mm

76,60 €

49

3/8" 10 mm
1/2" 10 mm



<30mm>			<70mm>			<200mm>		
●	●	●	●	●	●	●	●	●
HEX4	XZN5	T20	HEX4	XZN5	T20	T30		
HEX5	XZN6	T25	HEX5	XZN6	T25	T40		
HEX6	XZN8	T27	HEX6	XZN8	T27	T45		
HEX6	XZN10	T30	HEX6	XZN10	T30			
HEX8	XZN12	T40	HEX8	XZN12	T40			
HEX10		T45	HEX10		T45	<100mm>		
HEX12		T50	HEX12		T50	●		
		T55			T55	T70		
		T60			T60	T80		

Sady nástrčných hlavíc a bitov na motory

1/2"

BE5101
Sada nástrčných
hlavic

40,80 €

9

Tamper TORX®



100 mm

T25 T27 T30 T40 T45 T50 T55 T60 T70



BE5102
Sada nástrčných
hlavic

40,80 €

9

RIBE



100 mm

RM5 RM6 RM7 RM8 RM9
RM10 RM11 RM12 RM13



BE5103
Sada nástrčných
hlavic

38,75 €

6

XZN



140 mm

M5 M6 M8 M10 M12 M14



ŠPECIÁLNE NÁRADIE NA MOTORY

BE256P3

Sada klieští na škrtenie hadíc

- Na škrtenie / blokovanie PVC hadíc

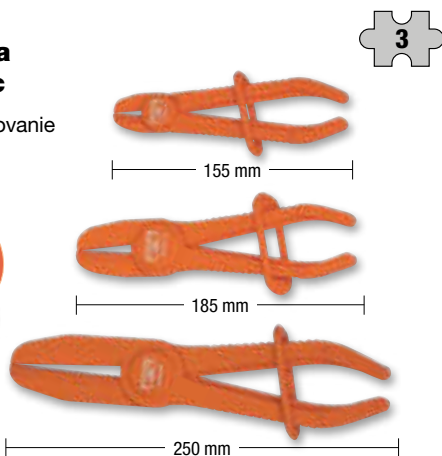

16,85 €

BLUVF UV LED Lampa

3 x
AA
vrátane



- Na sledovanie úniku plynu a kvapalín do klimatizácie

40,80 €

BE6FCP

Kliešte na palivový filter

- Pre údržbu benzínových motorov
- Na demontáž a výmenu spojov na palivovom filtri
- Špeciálne špičky uľahčujú zamykanie a odomykanie



14,90 €

BE254A

Kliešte na hadicové spony

- Pre bezpečnú a profesionálnu montáž a demontáž spon
- Priemer hadice Ø 18 – 53 mm



69,00 €

← 590 mm →

Flexibilná hlava pre prístup k ťažko dostupným sponám

Vrátane aretačnej a zamykacej funkcie

BE1FFWF

Kľúč na palivový filter vozidiel Ford 2.2TDCi

1/2"

- Na uvoľnenie a utiahnutie krytu palivového filtra pri výmene vložky palivového filtra
- Zabraňuje poškodeniu puzdra palivového filtra a montážneho krúžku
- Vhodný pre motory vyrobené v roku 2012 a neskôr



13,80 €

NÁRADIE NA VÝMENU OLEJA

BE6217

Sada nástrojných kľúčov na vypúšťacie zátky oleja

3/8"

17

	0-9-10-12-12-14-17 mm
	0-9-5-10-10-5-11-12-13, 1 mm
	10 mm
	10 mm
	10 mm



35,25 €

- Obsahuje XT-10 trojuholníkové a XZN M16 viachranné

Zahnuté štvorhranné kľúče

- Servisné kľúče na olejové výpuste
- Tvrdosť: 52-54 HRC
- Vysokovýkonná legovaná oceľ, poniklovaná a pochrómovaná



BAHCO		$\leftarrow \text{mm} \rightarrow$	€
BE6810	8-10 mm	270	7,00
BE68	8-8 mm	235	4,30

Sady na opravu vypúšťacích otvorov oleja

- Na rýchlu obnovu poškodených závitov vypúšťacieho otvoru oleja vyrezaním nového závitu a montáž novej zátky
- Pomocou závitníka zväčšíte poškodený závit a vytvoríte nový závit pre novú zátku
- Veľkosti vhodné pre väčšinu výrobcov automobilov
- Závitník so 6 zodpovedajúcimi skrutkami a 12 medenými tesniacimi krúžkami



BAHCO		€
BOD101	M13 x 1.25P	29,90
BOD102	M13 x 1.5P	29,90
BOD103	M15 x 1.5P	29,90
BOD104	M17 x 1.5P	35,90
BOD105	M20 x 1.5P	35,90
BOD106	M22 x 1.5P	41,90

BOD1016

Miska na vypúšťanie oleja

- Na jednoduché vypúšťanie oleja a iných kvapalín

Praktická výlevka

20,50 €



16 L



Odolná voči: olejom, chemikáliám, rope a nemrznúcej zmesi

445 mm

BOD2008

Nádžka na výmenu oleja

- Olejová vaňa na jednoduché vypúšťanie oleja a iných kvapalín

Integrovaná nádžba na čistú likvidáciu

26,00 €



8 L

PE



Odolná voči: olejom, chemikáliám, rope a nemrznúcej zmesi

NÁRADIE NA VÝMENU OLEJA

BE630

Sada klúčov na olejový filter

30



- Pokrýva väčšinu európskeho trhu s vozidlami
- Aplikačná tabuľka súčasťou sady
- Obsahuje 28 klúčov olejového filtra, 1 ks adaptér 1/2"-3/8" a 1 ks trojramenný klúč na olejové filtre

99,00 €

Klúče na olejový filter

- Na inštaláciu a demontáž ťažko prístupných olejových filtrov



BAHCO	Ø mm	3/8"	3/8"	€
BE6306514F	64	3/8"	14 pre Daihatsu, Fiat, Nissan, Toyota	4,60
BE6307614F	74	3/8"	14 pre Audi, BMW, Mercedes Benz, Opel, Porsche, VW	4,60

BE65F65120

Trojramenný klúč na olejový filter

3/8"

Ø 65-120 mm

9,90 €



- Ploché ramená zaručujú stabilné držanie všetkých typov olejových filtrov

BE65R65120

Magnetický trojramenný klúč na olejový filter

3/8" & 1/2"

Ø 21 mm

Ø 65-120 mm

19,90 €



- Optimálna kontrola pri uťahovaní / povoľovaní olejových filtrov

21 mm

Drážkované ramená pre lepšie držanie olejového filtra

Pásový klúč na olejový filter



BAHCO	Ø mm	€
BE61110	65-110	16,30
BE61155	100-155	16,30

Pásový klúč na olejový filter s gumenou rukoväťou



BAHCO	Ø mm	€
BE62110	65-105	16,90
BE62155	110-155	17,95



Retazové klúče na olejový filter



BAHCO	Ø mm	€
BE64520	60-160	40,80
BE64350	60-105	36,70

BE66152 Gumový pásový klúč

Ø 150 mm



- Na uchytenie, utiahnutie alebo uvoľnenie takmer všetkého ako sú matice, skrutky, olejové filtre, výfukové potrubia, remene atď.

Pogumovaná hliníková rukoväť

13,80 €

295,00 €



90 L

BOD8901
Gravitačný
vypúšťač oleja

- Na vypúšťanie znečisteného oleja z motorov, prevodoviek a diferenciálov všetkých vozidiel účinkom gravitácie
- Maximálny vypúšťací tlak: 1 Bar/14,5 PSI

397,00 €



90 L

BOD8902
Vzduchový
vypúšťač oleja

- Odpadový olej môže byť vypúšťaný pomocou gravitácie alebo pomocou sacieho mechanizmu z motorov, prevodoviek a diferenciálov všetkých vozidiel
- Maximálny vypúšťací tlak: 1 Bar/14,5 PSI
- Sací tlak: 7-8 Bar/100-115 PSI



90 L



9-litrová komora pre okamžitú vizuálnu kontrolu stavu oleja

BOD8903A
Vzduchový
vypúšťač oleja

- Odpadový olej môže byť vypúšťaný pomocou gravitácie alebo pomocou sacieho mechanizmu z motorov, prevodoviek a diferenciálov všetkých vozidiel
- Maximálny vypúšťací tlak: 1 Bar/14,5 PSI
- Sací tlak: 7-8 Bar/100-115 PSI

459,00 €

BE60FW
Montážny kľúč na olejové a palivové filtre

Ø 57-120 mm

Ozubené a pohyblivé čeluste pre optimálne uchytienie

42,90 €



Ø 57-120 mm

BOD60
Páková pumpa na čerpanie oleja zo sudov

1/2" + 2"

50-205 L

51,00 €



BOD70
Rotačná pumpa na čerpanie oleja zo sudov

1"

50-205 L

105,00 €

- Pumpa na vypúšťanie alebo napúšťanie

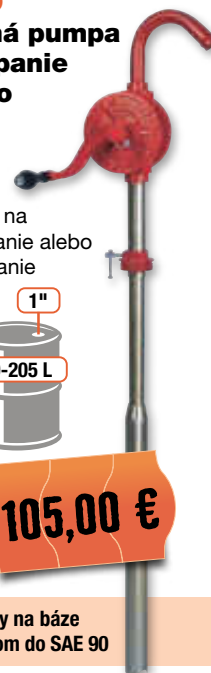

Odporúča sa pre kvapaliny na báze oleja s viskozitným indexom do SAE 90

AUTO-ELEKTRO

BBH12-1200

Hybridný booster 12 V 1200 CA

- Záložná lítiová batéria tiež štartuje vozidlá, ktorých akumulátor je vybitý
- 3 jednoduché a rýchle spôsoby nabíjania ultra kondenzátorov
 1. S vybitým akumulátorom cez svorky (60-120 sekúnd)
 2. S 12V DC pripojením, zapaľovač cigariet (4-6 minút)
 3. S integrovanou náhradnou lítiovou batériou (4-6 minút)
- Režim premostenia pre štartovanie vozidiel s vybitým alebo chýbajúcim akumulátorom



408,00 €

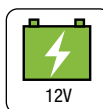

Video návody na použitie a údržbu



BBJL

Štartovacie káble

- Káble a svorky s úplnou izoláciou



BAHCO	mm ²	m	OTTO	DIESEL	A	kg	€
BBJL1630	16	3	2,5 L	1,5 L	500 A	1,34	16,25
BBJL2535	25	3,5	4,0 L	2,0 L	1000 A	3,30	40,80
BBJL3545	35	4,5	5,5 L	3,0 L	1000 A	4,80	61,25

BOOSTRE

BBA1224-1700

Booster 12 / 24 V 1.700 / 900 CA

- Napätie možno ľahko zmeniť premiestnením kábla
- Systém elektornickej kontroly poistky
- Automatická elektronická nabíjačka s 3 farebnými LED diódami
- K dispozícii je voliteľný 12V kábel do zapalovača cigariet BBSNL4FX001



12 V pripojenie s vnútornou 16 A poistkou na napájanie malých spotrebičov

715,00 €

30 kg

CE

BBA12-1200

Booster 12 V 1200 CA

- Na štartovanie naftových motorov výkonu do 350 HP s akumulátorom a 175 HP bez akumulátora
- Elektronická nabíjačka s 3 farebnými LED kontrolkami



Praktický voltmeter na kontrolu stavu internej batérie



12 V pripojenie s vnútornou 16 A poistkou na napájanie malých spotrebičov

299,00 €

16 kg

CE

BB10

Tester hustoty kyseliny v batérii

Sklenená trubica s jasne čitateľnou stupnicou

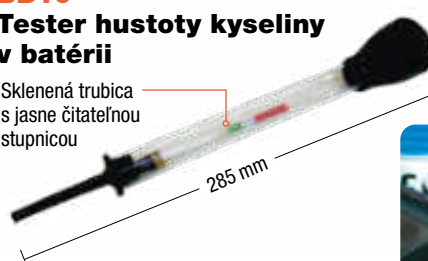

5,05 €

- Na kontrolu obsahu kyseliny batérie meraním hustoty elektrolytu



AUTO-ELEKTRO

BELMS120BDL

Ukladač obsahu pamäte centrálnej jednotky (OBD-L)

- Systém OBD-L automaticky detekuje, či elektronika vozidla umožňuje tomuto zariadeniu ukladať palubné údaje
- Jednoduché 3-krokové ovládanie

Ideálne pre boostery

- BBL12-400
- BBL12-800
- BBA12-1200
- BBA1224-1700



40,80 €



BELP1224

Prepätová ochrana 12V / 24V

- Chráni pred napätovými špičkami pri zváraní alebo výmene batérií



40,35 €



Automatická detekcia napätia

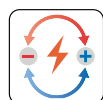

Ochrana proti prepólovaniu

BELMS12

Prepätová ochrana 12V

- Chráni pred napätovými špičkami pri zváraní alebo výmene batérií
- LED-ky indikujú správnu funkciu

32,75 €

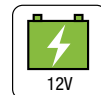

Plne automatický 8-fázový nabíjací cyklus

Skrátená životnosť batérie môže mať rôzne dôvody:

- Sulfácia: je spôsobená nedostatočným nabíjaním batérie
- Tvorba kyslíkových vrstiev: Vyskytuje sa pri hlboko vybitých batériách
- Vysušenie: Vyskytuje sa pri nebezpečnom preťažení kvôli odparovaniu „tekutiny z batérie“

Pravidelná starostlivosť a údržba zabraňujú predčasnemu vybitiu batérie, zabezpečujú plnú kapacitu batérie a tým predlžujú životnosť batérie.



8-fázový nabíjací cyklus nielen zvyšuje efektívnosť nabíjacieho procesu, ale zaručuje aj správny nabíjací proces, čím sa zabezpečí dlhšia životnosť batérie.



1. Analýza batérie
2. Obnovenie batérie
3. Mäkký štart
4. Režim hlavného nabíjania
5. Absorpcia
6. Monitorovanie
7. Režim konečného dobíjania
8. Udržiavanie



100% automatická prevádzka a riadenie mikroprocesorom



NABÍJAČKA AKUMULÁTOROV

BBCE612-2

2 A plnoautomatická mikroprocesorom riadená nabíjačka/dobíjačka akumulátorov, 8 fází nabíjania



BBCE12-3

3 A plnoautomatická mikroprocesorom riadená nabíjačka/dobíjačka akumulátorov, 8 fází nabíjania



BBCE12-6

6 A plnoautomatická mikroprocesorom riadená nabíjačka/dobíjačka akumulátorov, 8 fází nabíjania



BBCE12-10

10 A plnoautomatická mikroprocesorom riadená nabíjačka/dobíjačka akumulátorov, 8 fází nabíjania



BBCE12-15S

15 A plnoautomatická mikroprocesorom riadená nabíjačka/dobíjačka akumulátorov, 8 fází nabíjania s napájacím režimom



BBCE24-10

10 A plnoautomatická mikroprocesorom riadená nabíjačka/dobíjačka akumulátorov, 8 fází nabíjania



AUTO-ELEKTRO

BMVAT1000

1000 V tester napätia s LCD displejom

NOVINKA



- CAT IV 1000V
- Rozsah merania: 6-1000 V DC - 24-1000 V AC
- Detekcia polarity
- Funkcia automatického testu

IP65

79,00 €



BBT20

Digitálny tester batérií

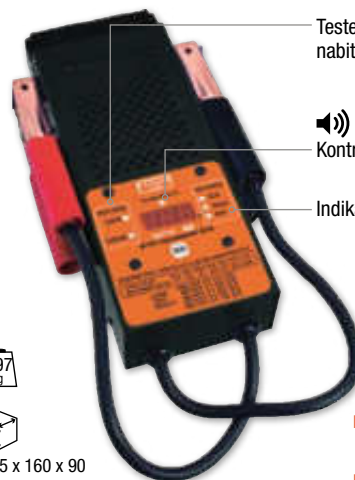

Tester a indikátor stavu nabitia akumulátora

Kontrola polarity

Indikátor stavu batérie

79,00 €

0,97 kg



345 x 160 x 90 mm

- Funkcia na testovanie alternátora
- 200 – 1000 CCA



DIAGNOSTIKA ELEKTRONIKY

BMMTRMS1

Digitálny multimeter s prípojkou k PC

- Pre kontrolu AC/DC napätia, prúdu, frekvencie, odporu, kapacity, vodivosti, polaritu ako aj teploty

102,00 €

12 jazykov + PC softvér



1 x 9V vrátane



Silikónový testovací kábel

Cat III 1000V, 10A

Kábel sondy T°

Cat III 1000V, 10A

Technické špecifikácie:

- Meranie RMS skutočnej efektívnej hodnoty
- Bezkontaktná skúška napätia
- Relatívne meranie
- Automatické vypínanie
- Zálohovanie dát
- Podsvietenie
- Automatické/manuálne nastavenie rozsahu
- Indikácia polaritu
- Test diód
- Test kontinuity
- Indikácia vybitie batérie
- Rozsah DC jednosmerného napätia: 600mV ± 0,5%, 6V / 60V / 600V ± 0,8%, 1000V ± 1,0%
- Rozsah AC striedavého napätia: 600mV / 6V / 600V ± 1,0%, 1000V ± 1,5%
- DC jednosmerný prúd: 600uA / 6mA / 60mA / 600mA / 10A ± 1,5%
- Kategórie merania: CAT III 1000V, CAT IV 600V
- Odpor: 600Ω / 6KΩ / 60KΩ / 600KΩ / 6MΩ ± 0,5%, 60MΩ ± 1,5%
- Kapacita: 6nF ± 3,0%, 60nF / 6uF / 60uF / 300uF ± 5,0%
- Logická frekvencia: 10Hz ~ 1MHz ± (0,1% + 3)
- Lineárna frekvencia: 10Hz ~ 10KHz ± (0,05% + 8)
- Pracovný cyklus: 1% ~ 99%
- Teplota: -55 °C ~ 1000 °C ± (2% + 2)
- Poistky: 0,63A/1000Vx1 pre μA a mA & rozsahy a 10 A/1000 Vx1 pre 10A rozsah

BELTRP16

Univzálna sada svoriek

16



Model	Príslušenstvo	Príslušenstvo	Príslušenstvo	Príslušenstvo
BELTRP1601	16 svoriek	16 svoriek	16 svoriek	16 svoriek
BELTRP1602	16 svoriek	16 svoriek	16 svoriek	16 svoriek
BELTRP1603	16 svoriek	16 svoriek	16 svoriek	16 svoriek
BELTRP1604	16 svoriek	16 svoriek	16 svoriek	16 svoriek
BELTRP1605	16 svoriek	16 svoriek	16 svoriek	16 svoriek
BELTRP1606	16 svoriek	16 svoriek	16 svoriek	16 svoriek
BELTRP1607	16 svoriek	16 svoriek	16 svoriek	16 svoriek
BELTRP1608	16 svoriek	16 svoriek	16 svoriek	16 svoriek
BELTRP1609	16 svoriek	16 svoriek	16 svoriek	16 svoriek
BELTRP1610	16 svoriek	16 svoriek	16 svoriek	16 svoriek
BELTRP1611	16 svoriek	16 svoriek	16 svoriek	16 svoriek
BELTRP1612	16 svoriek	16 svoriek	16 svoriek	16 svoriek
BELTRP1613	16 svoriek	16 svoriek	16 svoriek	16 svoriek
BELTRP1614	16 svoriek	16 svoriek	16 svoriek	16 svoriek
BELTRP1615	16 svoriek	16 svoriek	16 svoriek	16 svoriek
BELTRP1616	16 svoriek	16 svoriek	16 svoriek	16 svoriek

- Univzálne použiteľné pre množstvo elektronických komponentov vozidla
- Vhodné pre väčšinu európskych značiek vozidiel

99,00 €

KAROSÉRIE

BBS3UH Držiak častí karosérie

- Vrátane nastaviteľných konzol a háčikov

235,00 €



max.
20
kg

max.
1160 x 1000 x 1350
mm

BLBT100 Laserový regloskop



- Digitálny luxmeter
- Nastaviteľné vnútorné zobrazenie nameraných hodnôt, použiteľné pre vozidlá s ľavostranným a pravostranným riadením
- CE a NFR63-801 certifikované



- Laserové meranie odchýlok a centrovania

- Vhodný pre všetky typy svetlomietov



Halogen, XENON, LED, Audi Matrix-LED

240 – 1400
mm

360°

769,00 €



BBS50 Ochranný kryt blatníkov

- S magnetmi a prísavkami
- 900 x 580 mm

20,35 €



BBS3BH1 Univerzálny držiak s prísavkami



Nastaviteľné retiazky

122,00 €

max.
170
kg



Odnímateľné prísavky, spodná pena chráni pred poškriabaním častí vozidla

BBS20P12 Sada na odstraňovanie čalúnenia a obloženia

- Vyrobené z nylonu a sklolaminátu

12



36,70 €



BBS150 Sada dvoch prísaviek s popruhom

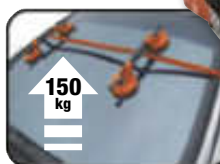

150
kg

Ø 120 mm

89,00 €



BBS200 Kliešte na odstraňovanie čalúnenia dverí

- Na odstránenie ozdobných pásov, obkladov, spŕn a na jemné uvoľnenie spŕn



240 mm

19,90 €



2485 Odstraňovač krytov a panelov čalúnenia

5,75 €



240 mm

BH8PR4000 Sada narážačov 4 t

- Na lisovanie, upínanie a rozťahovanie častí karosérie
- Vrátane hydraulického ručného čerpadla a tlakového valca 4 t, predlžovacích rúrok, prítlačnej dosky a rôznych prídavných zariadení



Item#	Part Code	Description
1	BH8PR4000-01	MAIN PUMP SET
2	BH8PR4000-02	RUBBER SADDLE
3	BH8PR4000-03	OPEN CLAMP
4	BH8PR4000-04	EXTENSION TUBE 1#
5	BH8PR4000-05	EXTENSION TUBE 2#
6	BH8PR4000-06	EXTENSION TUBE 3#
7	BH8PR4000-07	EXTENSION TUBE 4#
8	BH8PR4000-08	EXTENSION TUBE 5#
9	BH8PR4000-09	SQUARE SADDLE
10	BH8PR4000-10	OFFSET SADDLE WITH THREAD
11	BH8PR4000-11	OFFSET SADDLE
12	BH8PR4000-12	SHARP SADDLE
13	BH8PR4000-13	CONNECTION PART
14	BH8PR4000-14	WORK PISTON SET
15	BH8PR4000-15	OIL HOSE
16	BH8PR4000-16	ROUND SADDLE
17	BH8PR4000-17	CROSS SADDLE
18	BH8PR4000-18	PLASTIC CASE
19	BH8PR4000RC	CONNECTOR
20	BH8PR4000-20	CONNECTOR

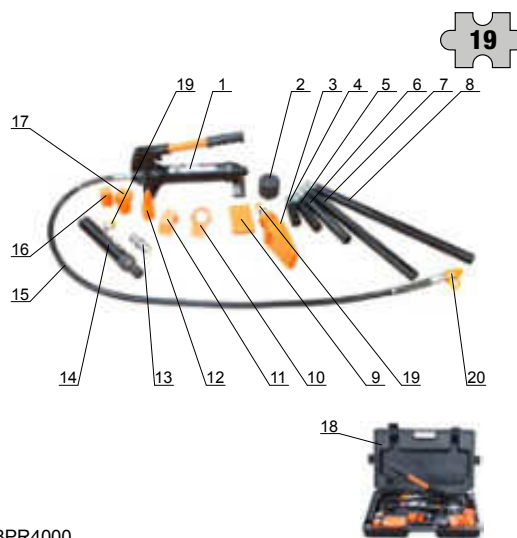

BH8PR4000



163,00 €

BH8PR10000 Sada narážačov 10 t

- Na lisovanie, upínanie a rozťahovanie častí karosérie
- Vrátane hydraulického ručného čerpadla a tlakového valca 10 t, predlžovacích rúrok, prítlačnej dosky a rôznych prídavných zariadení



245,00 €



Item#	Part Code	Description
1	BH8PR10000-01	MAIN PUMP SET
2	BH8PR10000-02	RUBBER SADDLE
3.1	BH8PR4000-03	OPEN CLAMP
3.2	BH8PR10000-03	EXTENSION TUBE 1#
4	BH8PR10000-04	EXTENSION TUBE 2#
5	BH8PR10000-05	EXTENSION TUBE 3#
6	BH8PR10000-06	EXTENSION TUBE 4#
7	BH8PR10000-07	SQUARE SADDLE
8	BH8PR10000-08	OFFSET SADDLE WITH THREAD
9	BH8PR10000-09	OFFSET SADDLE
10	BH8PR10000-10	SHARP SADDLE
11	BH8PR10000-11	CONNECTION PART
12	BH8PR10000-12	WORK PISTON SET
13	BH8PR10000-13	OIL HOSE
14	BH8PR10000-14	ROUND SADDLE
15	BH8PR10000-15	CROSS SADDLE
16	BH8PR10000-16	PLASTIC CASE
19	BH8PR4000-19	CONNECTOR
20	BH8PR4000-20	CONNECTOR

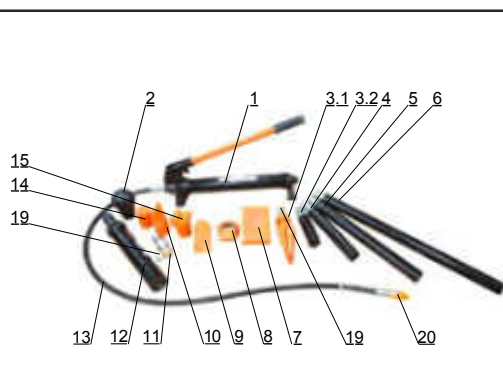

KONTROLA / SVIETIDLÁ

BE210

Videoskop s LCD displejom

Bahco BE210 ručný Videoskop umožňuje jednoduchú dokumentáciu akejkoľvek práce. Tenký kábel objektívu umožňuje prístup do takmer všetkých ťažko dostupných miest. Digitálny zoom odhaľuje najmenšie detaily, ako napríklad poškodené vlákna, závit a trhlinky.

- 4 výkonné LED diódy s až 850 LUX (pri 10 cm) a plynulou reguláciou intenzity svetla
- Široký sortiment vymeniteľných kamerových sond
- Možné je zrkadlenie a rotácia obrázkov priamo v zariadení
- Jednoduchý prenos obrázkov a videí do počítača alebo monitora

PC softvér v
21 jazykoch

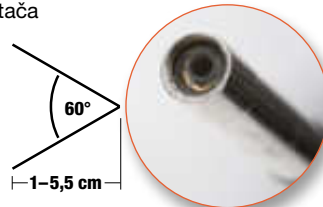

Obsah kufru

- Ručný Videoskop
- Polotuhý kábel, dĺžka 1 m, Ø 5,8 mm
- 1 GB pamäťová karta
- 3 zrkadlové moduly 35°, 45° a 55° ako aj magnetický modul
- Protišmykový gumený ochranný obal
- Mini USB kábel • TV kábel
- Čistič displeja
- Nabíjačka 100-230V



- 3,5" farebný LCD displej, 320 x 240 pixelov
- Bezpečnostné sklo odolné voči olejom a poškrabaniu
- Odolné puzdro absorbujúce nárazy
- Tlačidlá sa ľahko ovládajú aj v rukaviciach

879,00 €

BE200

Inšpekčná kamera s LCD displejom



- ZNa kontrolu potrubí, rúrok, motorov, ventilačných systémov a iných ťažko dostupných miest
- 6 výkonných LED diód s až 850 LUX (pri 10 cm) a plynulou reguláciou intenzity svetla
- Široký sortiment vymeniteľných kamerových sond



Obsah kufru

- Ručný endoskop s inšpekčnou kamerou
- Polotuhý kábel, dĺžka 1 m, Ø 8 mm
- 3 prídavné zrkadlá 35°, 45° a 55°, ako aj magnetický modul
- 4 batérie AA
- Čistič displeja



- 2,5" farebný LCD displej
- Bezpečnostné sklo odolné voči olejom a poškrabaniu
- Protišmykový gumený ochranný obal tlmíaci nárazy

322,00 €



BLTS7P

Ceruzková baterka

- 7 SMD LED
- 45 Lumen
- 4 USB
- IP20



23,95 €



BLTS10

Tenká vrecková baterka

- 10 SMD LED
- 180 Lumen
- 4 USB
- 2100 mAh-s Li-ion
- IP20

36,50 €

BFRL11

Čelovka

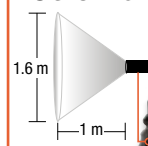

- 260 Lumen



46,95 €

- 2 režimy digitálneho osvetlenia: úsporný ekonomický (20%), maximálny (100%)
- batérie sú súčasťou balenia

BE220
Dielenský stetoskop, elektronický



143,00 €

Obsahuje prepínač k aktivácii rôznych senzorov, ktoré sú farebne odlišené

Obsah

- Na počúvanie a identifikáciu hluku motora a pohyblivých častí v podvozku
- Poskytuje rýchle a jasné výsledky testov na zvuky

- 6 káblových svoriek
- Ručný stetoskop
- Sonda
- Slúchadlá
- 2 9V batérie

BLT550
Infračervený teplomer

- Jednoduché a bezkontaktné meranie povrchovej teploty motora, brzdových kotúčov, chladiacej kvapaliny, klimatizácie, výfukového systému, častí strojov, kúrenia atď.
- 9V batéria nie je súčasťou balenia



± 1,5 %

0,1 °C

-50 °C - +550 °C

D:S 12:1

500 ms

8-14 μm

28,50 €

2510
Ohybné dielenské zrkadielko

50x70 mm

25,45 €

Polohu zrkadla je možné nastaviť pomocou rukoväte



5515T
Vreckové teleskopické zrkadielko s kíbom

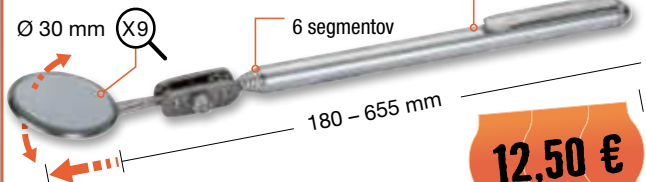

12,50 €

5515T-52
Vreckové teleskopické zrkadielko

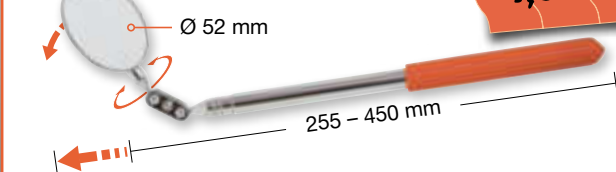

7,90 €

5515B
Údržbárske zrkadielko

- Ideálne pre prácu na elektrických obvodoch

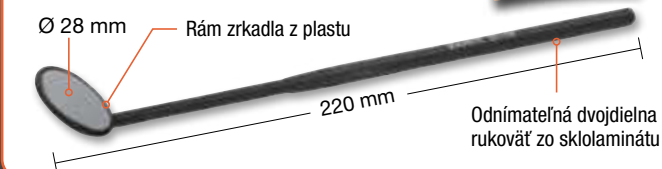

7,50 €

3046-REF
Optický tester - Refraktometer

- Meranie obsahu nemrznúcej zmesi v chladiacej kvapaline
- Kontrola kvality prevádzkovej kvapaliny (AD Blue)
- Kontrola hustoty kyseliny v batérii (stav nabitia batérie)



Gumené držadlo



Hlava a hranol z ocele a skla



Zaostrovací okulár s očnícou, s ostrou, ľahko čitateľnou stupnicou



70,00 €

Rozsah merania

- -50 °C až 0 °C (propylénglykol)
- -50 °C až 0 °C (etylénglykol)
- -40 °C až -10 °C (odolnosť kvapaliny do ostrekovača proti zamrznutiu)
- 1,10 až 1,40 kg/l pre hustotu kyseliny v akumulátore
- 5 % až 40 % pre obsah močoviny (AD Blue)

POZNÁMKY



POZNÁMKY



BAHCO®



SNA Europe [Slovakia] s.r.o.
Karadžičova 8/A, 821 08 Bratislava
Tel.: +421 2 5939 6124
Fax: +421 2 5939 6217
e-mail: info.sk@snaeurope.com
www.bahco.com/sk-sk/

www.bahco.com

SNA Europe
SK akut 210154. Printed in Germany.